

2021  
EDITION



**PRAISE**  
Corporation

Excellence in Quality Instruments



**DENTAL INSTRUMENTS**

[www.praise.com.pk](http://www.praise.com.pk)





# EXTRACTING FORCEPS (English Pattern)

Daviers (Forme Anglaise)  
щипцы экстракционные

Forceps de Extracción (Forme Inglesa)  
Щипці Екстракційні

Zahnzangen (Englische Form)



**01-100**  
Fig. 1  
Incisivi e canini superiori  
Upper incisors and canines  
Incisives et canines supérieures  
Incisivos y caninos superiores



**01-101**  
Fig. 07  
Incisivi e canini superiori  
Upper incisors and canines  
Incisives et canines supérieures  
Incisivos y caninos superiores



**01-102**  
Fig. 13  
Incisivi e premolari inferiori  
Lower incisors and premolars  
Incisives et prémolaires inférieures  
Incisivos y premolares inferiores



**01-103**  
Fig. 17  
Molari superiori destri  
Upper molars right  
Molaires supérieure droites  
Molares superiores derechos



**01-104**  
Fig. 18  
Molari superiori sinistri  
Upper molars left  
Molaires supérieure gauches  
Molares superiores izquierdos



**01-105**  
Fig. 22  
Molari inferiori  
Lower molars  
Molaires inférieure  
Molares inferiores



**01-106**  
Fig. 31  
Premolari superiori  
Upper premolars  
Prémolaires supérieure  
Premolares superiores



Daviers (Forme Anglaise)  
щипцы экстракционные

Forceps de Extracción (Forme Inglesa)  
Щипці Екстракційні

Zahnzangen (Englische Form)



**01-107**  
Fig. 49  
Radici superiori molto sottili  
Very thin upper root  
Racines supérieurs très fines  
Raíces superiores muy delgadas



**01-108**  
Fig. 34  
Incisivi e premolari superiori attacco profondo  
Upper incisors and premolars deep-gripping  
Incisives et prémolaires supérieurs à attaque profonde  
Incisivos y premolares superiores a sujeción profunda



**01-109**  
Fig. 36  
Premolari inferiori attacco profondo  
Lower premolars deep-gripping  
Prémolaires inférieurs à attaque profonde  
Premolares inferiores a sujeción profunda



**01-110**  
Fig. 36N  
Premolari inferiori attacco profondo  
Lower premolars deep-gripping  
Prémolaires inférieurs à attaque profonde  
Premolares inferiores a sujeción profunda



**01-111**  
Fig. 46  
Radici inferiori  
Lower root  
Racines inférieurs  
Raíces inferiores



**01-112**  
Fig. 51  
Radici superiori  
Upper root  
Racines supérieurs  
Raíces superiores



**01-113**  
Fig. 59  
Radici superiori  
Lower root  
Racines inférieurs  
Raíces inferiores





## Extracting Forceps (American Pattern)

Daviers - forme américaine  
Извлечение щипцы - американская форма

Pinzoper per estrazione - forma americana  
Витяг щипці - американська форма

Fórceps de extracción - forma americana

### Carbide Tipped Root Tip Forceps

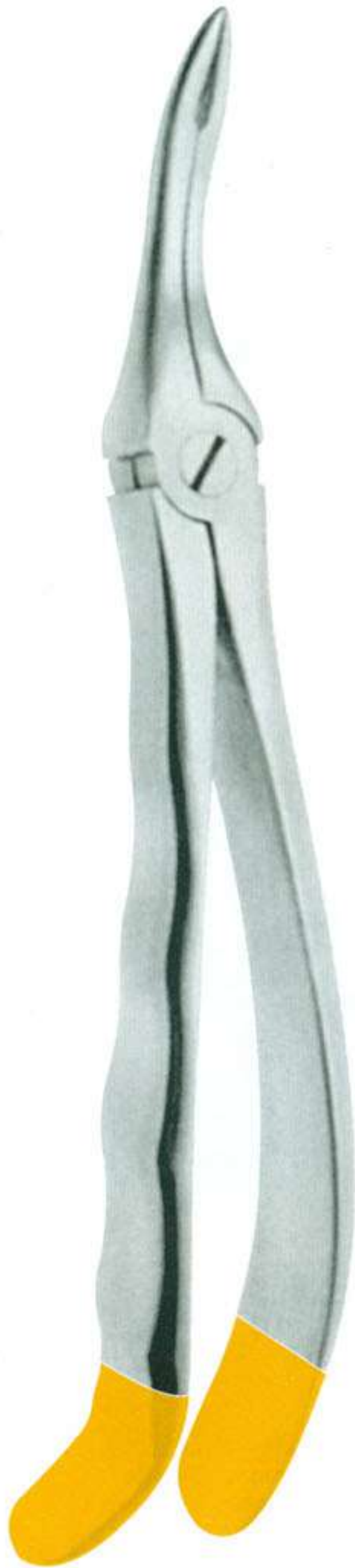

**01-268**  
T.C.  
Carbide Serrated Beak  
Lower Root Tips & Molars



**01-269**  
Root Tip-Lower  
Carbide Serrated Beak  
Lower Root Tips & Molars



**01-270**  
Root Tip-Upper  
Carbide Serrated Beak  
Lower Root Tips & Molars





## Extracting Forceps (American Pattern)

Daviers - forme américaine  
Извлечение щипцы - американская форма

Pinzeper per estrazione - forma americana  
Витяг щипці - американська форма

Fórceps de extracción - forma americana

Carbide Tip Extraction Forceps - Better Grip & Tactile Feel - Less Trauma

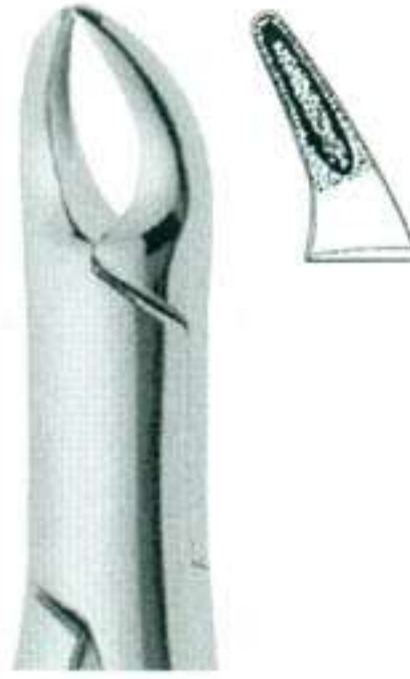

**01-275**  
150 T.C.  
Carbide Serrated Beak  
Upper Incisors, Cuspids,  
Bicuspid & Roots, Universal



**01-276**  
151 T.C.  
Carbide Serrated Beak  
Lower Incisors, Cuspids,  
Bicuspid & Roots, Universal

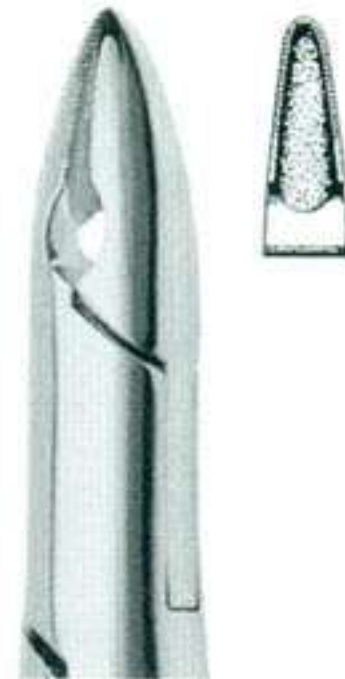

**01-277**  
1STD T.C.  
Carbide Serrated Beak  
Upper Incisors, Cuspids,



**01-278**  
17 T.C.  
Carbide Serrated Beak  
1st & 2nd Lower Molars,  
Universal

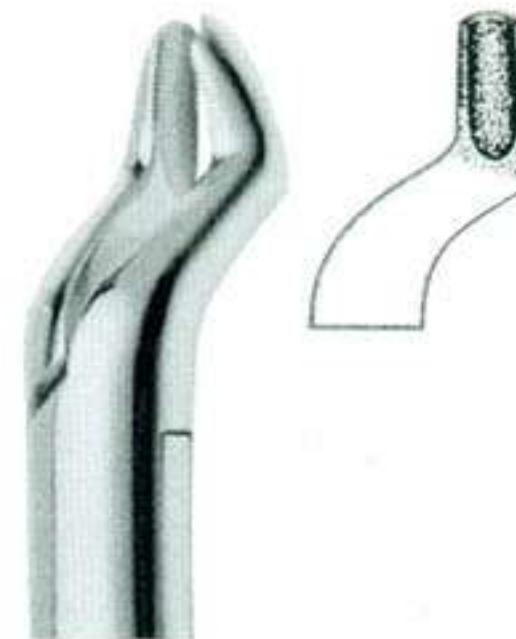

**01-279**  
53L T.C.  
Carbide Serrated Beak  
1st & 2nd Upper Molars, Left





## Extracting Forceps (American Pattern)

Daviers - forme américaine  
Извлечение щипцы - американская форма

Pinzeper per estrazione - forma americana  
Витяг щипці - американська форма

Fórceps de extracción - forma americana

Carbide Tip Extraction Forceps - Better Grip & Tactile Feel - Less Trauma



**01-280**  
53R T.C.  
Carbide Serrated Beak  
1st & 2nd Upper Molars, Right



**01-281**  
65 T.C.  
Carbide Serrated Beak  
Upper Incisors, Roots & Fragments



**01-282**  
69 T.C.  
Carbide Serrated Beak  
Upper & Lower Fragments  
And Roots

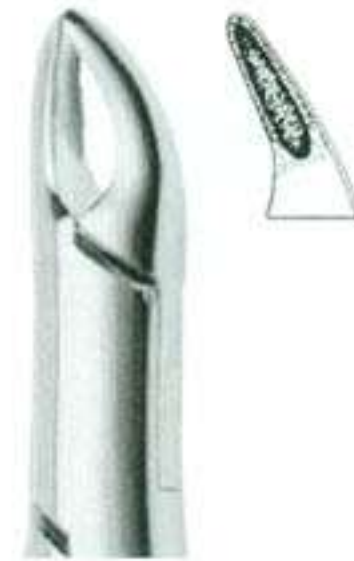

**01-283**  
150S T.C. Pedro forcep  
Carbide Serrated Beak  
Pedo, Upper Primary Teeth and  
Roots, Universal



**01-284**  
151S T.C. Pedro forcep  
Carbide Serrated Beak  
Pedo, Lower Primary Teeth and  
Roots, Universal



Seringues à usage dentaire  
Шприцы стоматологические

Jeringas dentales  
Стоматологічні шприци

Dentalspritzen

Intraligamental syringes



**01-343**  
Pistol-Ject  
1.8ml.

Injects 0.20 ml with every click  
Lever action for high injection pressure

Plastic protection tube

**01-344**  
Autoclavable



**01-345**  
# 1001  
Intraligamental  
Anesthesia Syringe  
in Black Colour  
Auto Cleavable

Intraligamental syringes  
Injects 0.06 ml with every click

**01-346**  
Swedish Type  
1.8ml.



**01-347**  
Falcon-Ject angled  
1.8 ml.



**01-348**  
Falcon-Ject straight  
1.8 ml.



**01-349**  
Quatro Type  
1.8 ml.



**01-350**  
Trio Type  
1.8 ml.



**01-351**  
Type A  
1.8 ml.

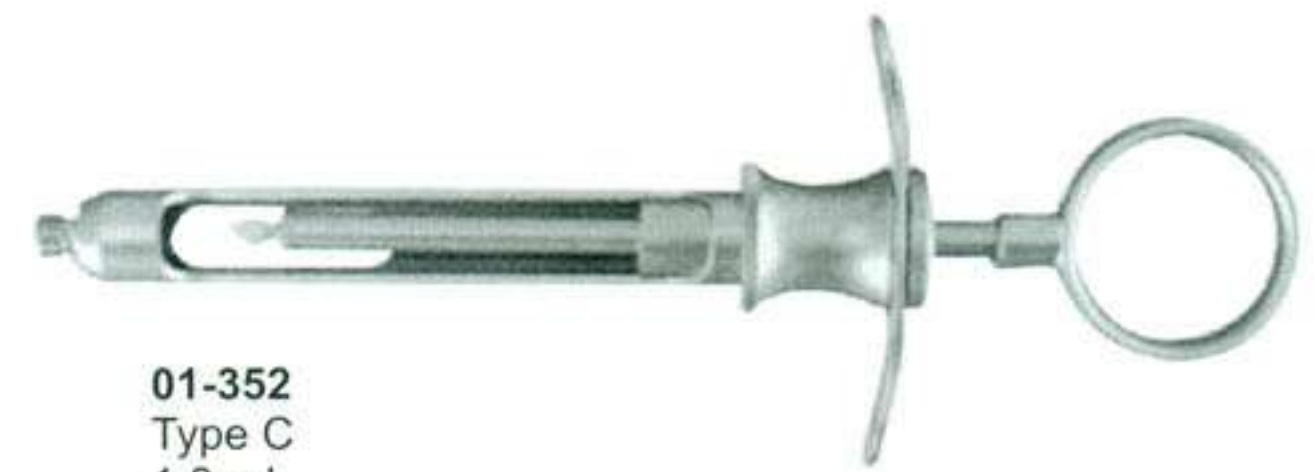

**01-352**  
Type C  
1.8 ml.

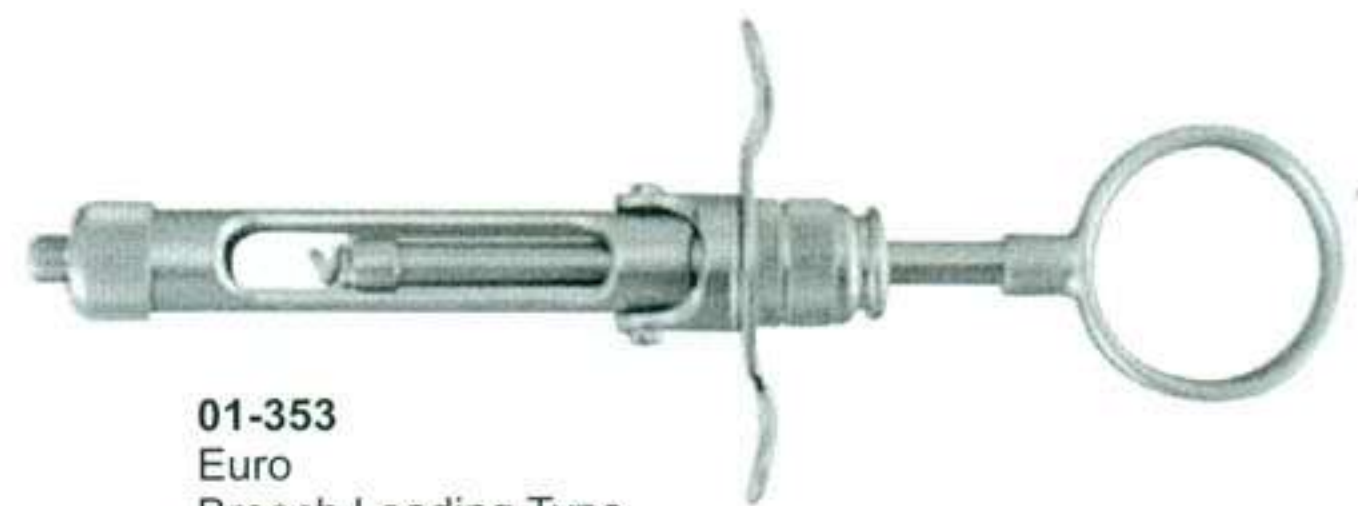

**01-353**  
Euro  
Breech Loading Type  
1,8ml.





# DENTAL SYRINGES

Seringues à usage dentaire  
Шприцы стоматологические

Jeringas dentales  
Стоматологічні шприци

Dentalspritzen



**01-365**  
Euro  
Breech loading Type  
1,8ml.



**01-369**  
Disc system  
1,8ml.

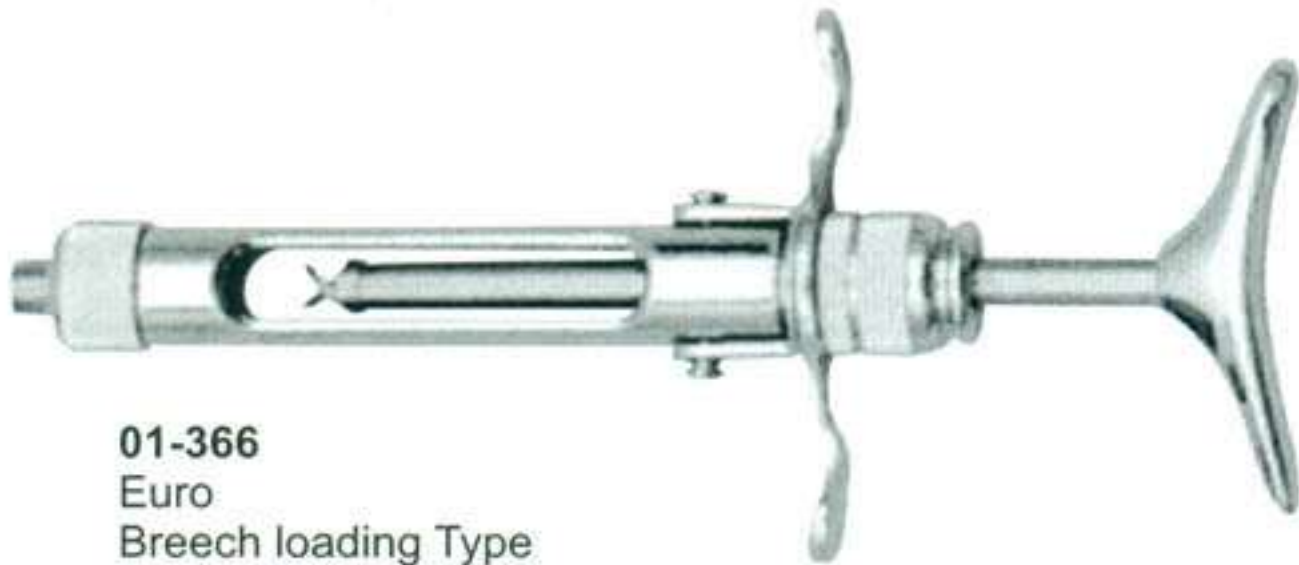

**01-366**  
Euro  
Breech loading Type  
1,8ml.



**01-370**  
Projection system  
1,8ml.

## Self Aspirating Syringes



**01-367**  
Disc system  
1,8ml.

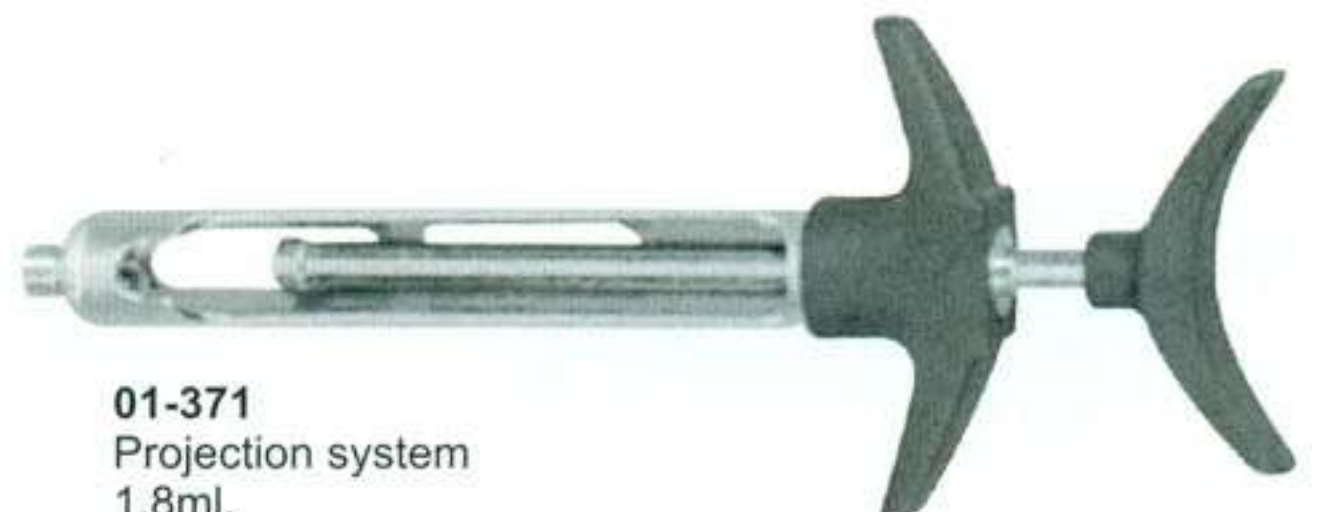

**01-371**  
Projection system  
1,8ml.



**01-368**  
Disc system  
1,8ml.

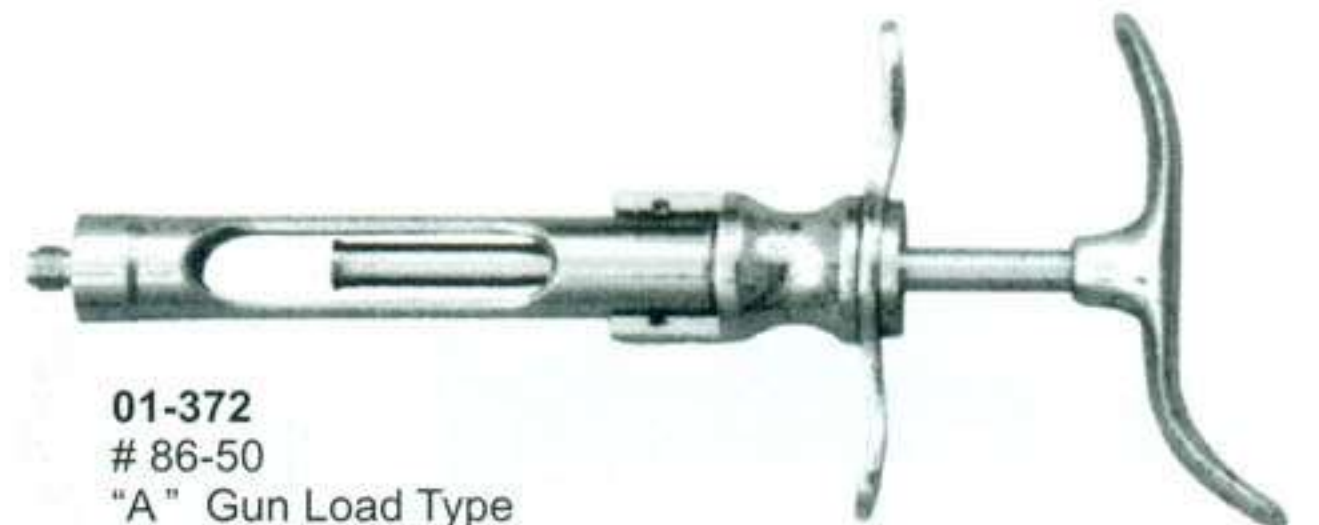

**01-372**  
# 86-50  
"A" Gun Load Type





# ROOT ELEVATORS

Elévateurs à racines  
Зтеваторы корневые

Elevadores para raices  
Елеватори екстракційні

Wurzelheber



02-100  
# 1  
straight  
Bein



02-101  
Fig. 1B  
Bein



02-102  
Fig. 2B  
Bein



02-103  
Fig. 3B  
Bein



02-104  
Fig. 4B  
Bein



02-105  
Fig. 5B  
Bein



02-106  
Fig. 6B  
Bein



02-107  
Fig. 4  
straight



02-108  
White



02-109  
White



02-110  
Berten



02-111  
Fig. 2  
Bein



02-112  
Fig. 3  
Bein



02-113  
Fig. 4  
Bein



02-114  
Fig. 1  
Bein



02-115  
Fig. 2  
Bein





# ROOT ELEVATORS

Elévateurs à racines  
Зтеваторы корневые

Elevadores para raices  
Елеватори екстракційні

Wurzelheber



Hylin



02-116  
# 1  
Hylin  
4,5mm



02-117  
# 2  
Hylin  
3mm



02-118  
# 3  
Hylin  
3mm



02-119  
# 4  
Hylin  
3mm



02-120  
# 1



02-121  
# 2  
Lindo-Levien



02-122  
# 3





# ROOT ELEVATORS

Elévateurs à racines  
Зтеваторы корневые

Elevadores para raices  
Елеватори екстракційні

Wurzelheber

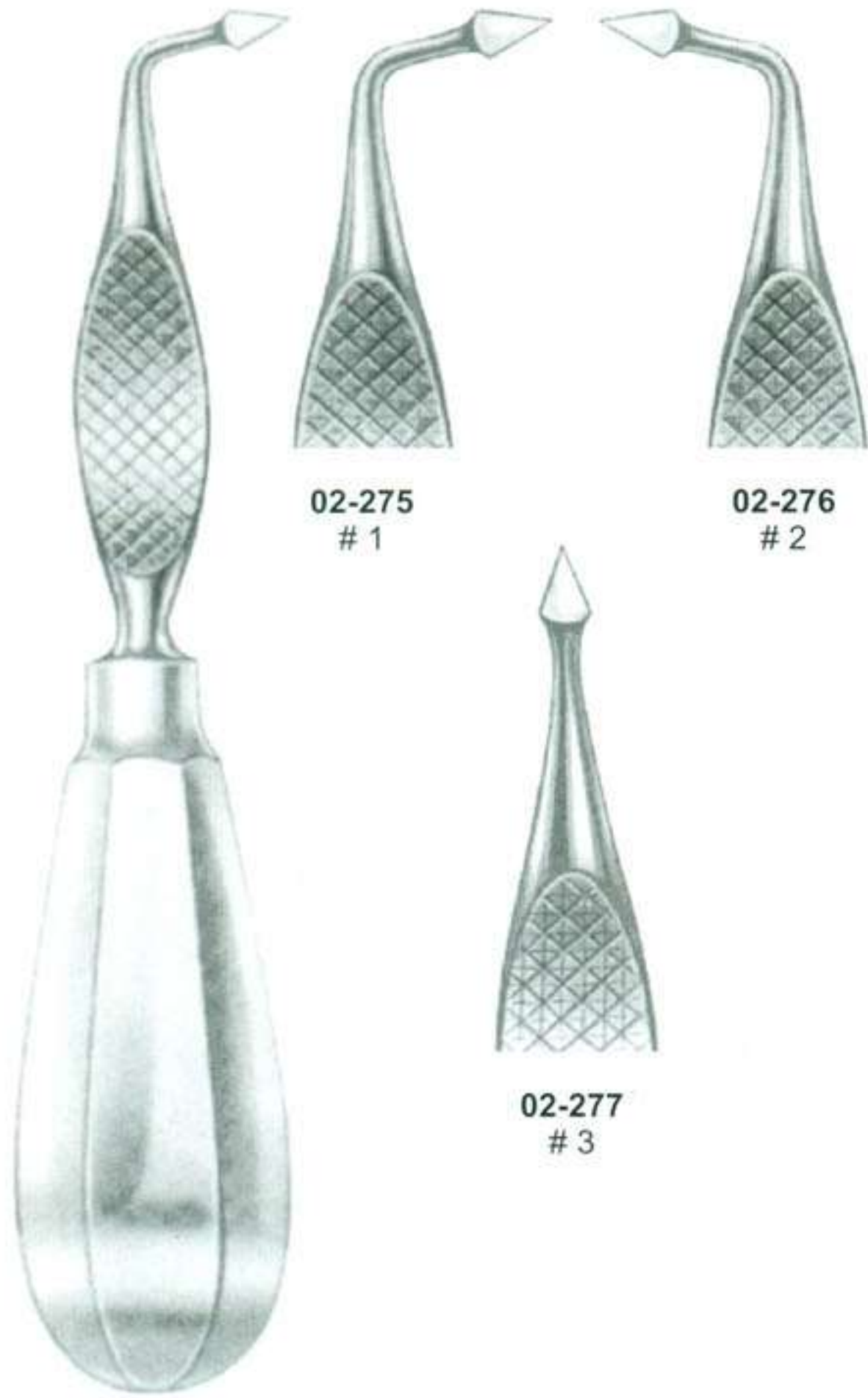

02-275  
# 1

02-276  
# 2

02-277  
# 3

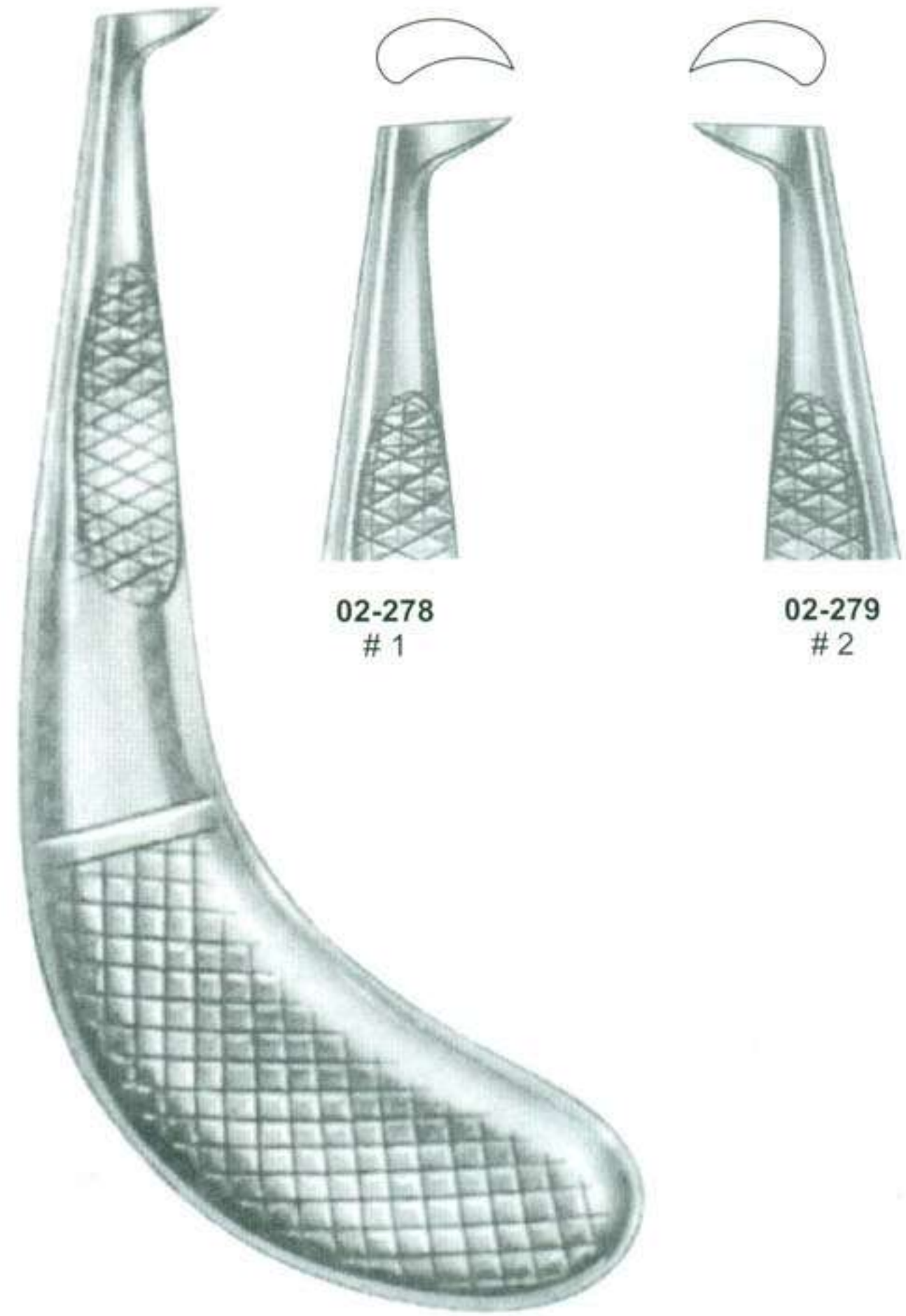

02-278  
# 1

02-279  
# 2



02-280  
# 1



02-281  
# 2



02-282  
# 3



02-283  
# 4







# SYNDESMOTOMES

syndesmotome  
Елеватори (сіндусмотоми)

Elevadores para raices  
Элеваторы (синдусмотомы)



Syndesmotomes  
11 cm



02-323  
Fig. 0



02-324  
Fig. 1



02-325  
Fig. 2



02-326  
Fig. 3



02-327  
Fig. 4



02-328  
Fig. 5



02-329  
Fig. 6



02-330  
Fig. 7



02-331  
Fig. 8



02-332  
Fig. 9



02-333  
Fig. 11





# HANDLES FOR MOUTH MIRRORS - MOUTH MIRRORS

Miroirs à bouche — Manches pour miroirs à bouche  
Ручки для зеркал рот - рот зеркала

espojos de boca — Mangos para espejos de boca  
Ручки для дзеркал рот - рот дзеркала

## Mundspiegel Mundspiegelgriffe

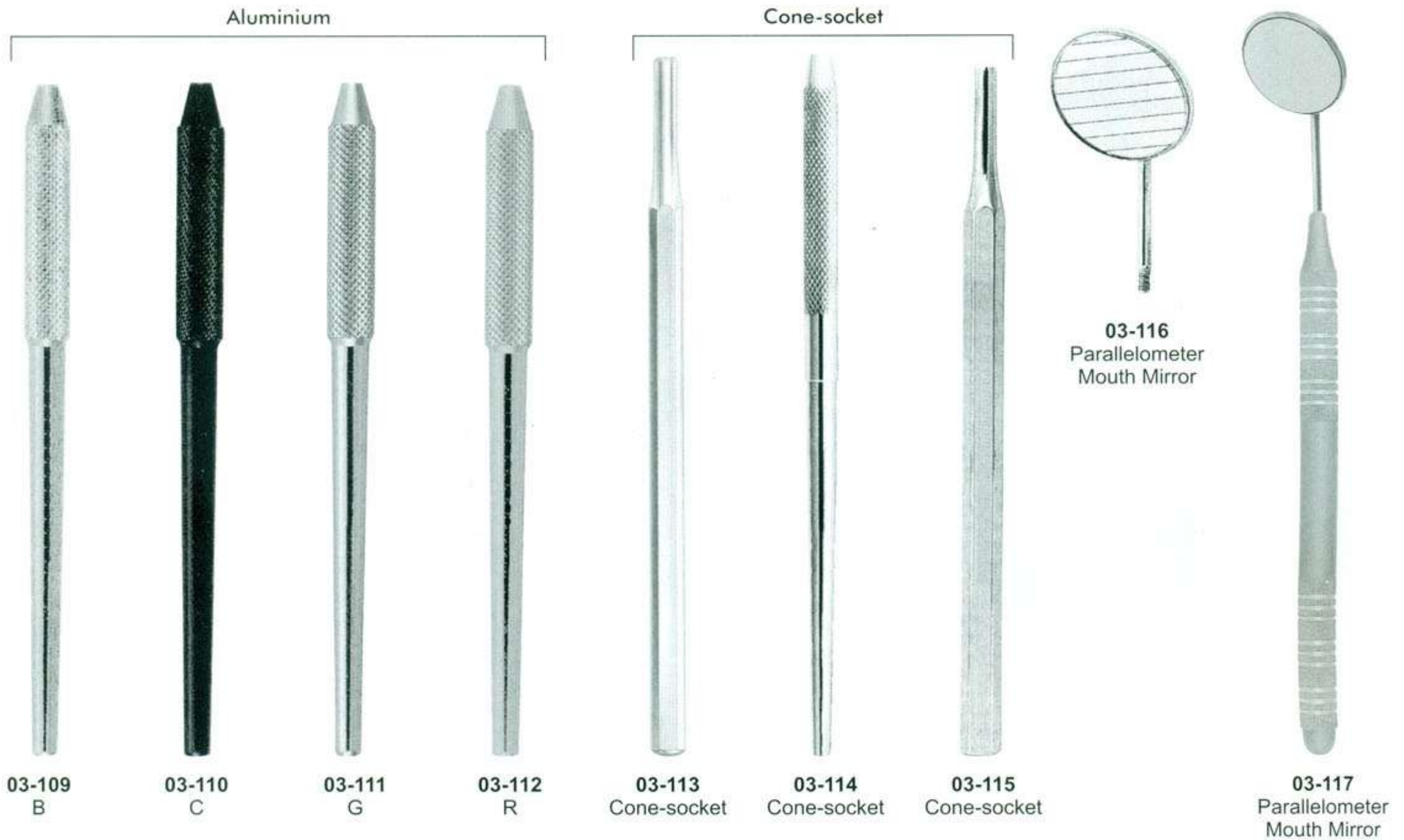





## HANDLES FOR MIRRORS

Manches pour miroirs à bouche  
Рукоятки для зеркал

Mangos para espejos de boca  
Рукоятки для дзеркал

Mundspiegelgriffe

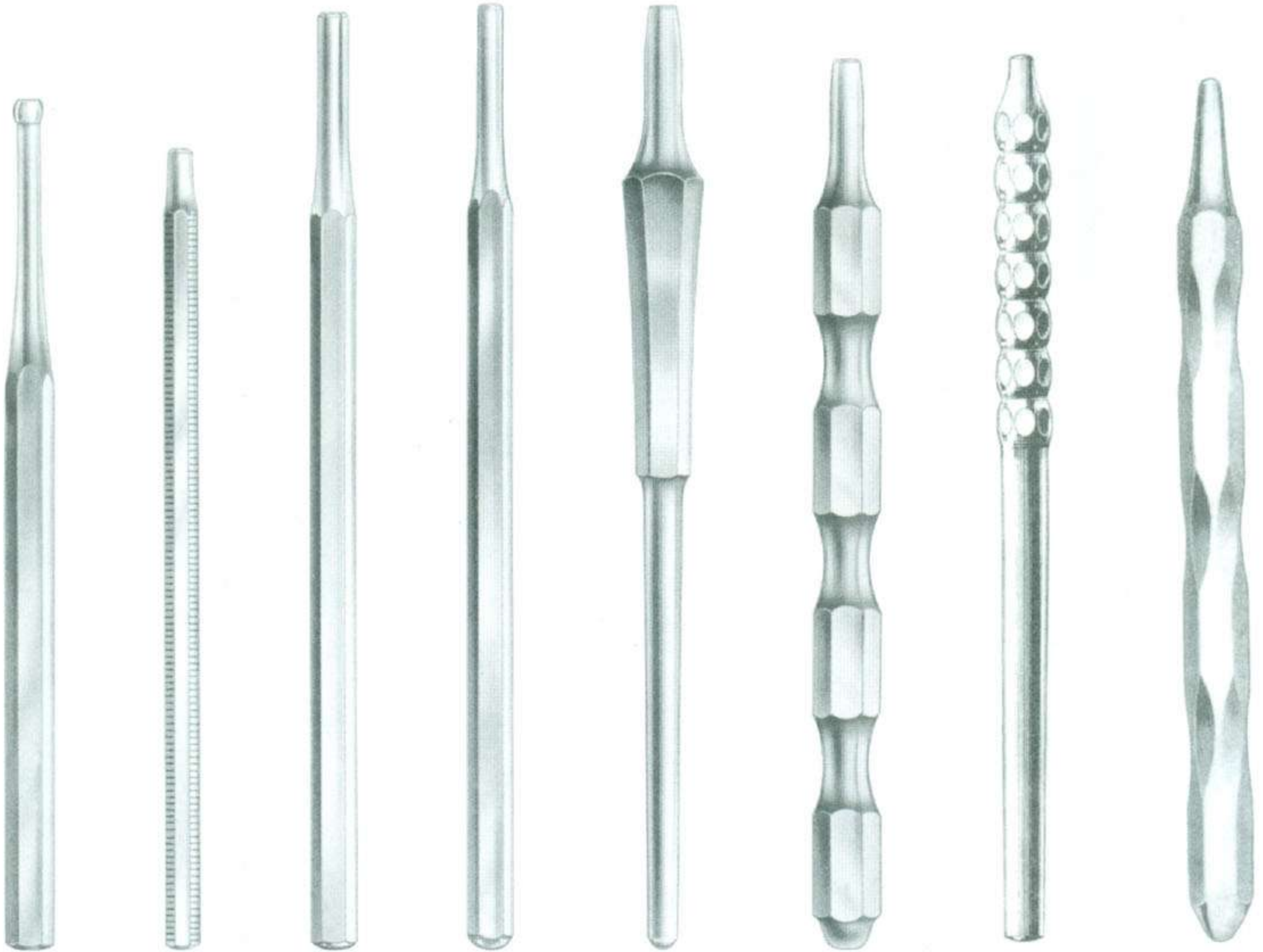

03-124  
Hollow  
Chromium  
Plated

03-125  
Solid  
stainless

03-126  
Hollow  
stainless

03-127  
Hollow  
stainless

03-128  
Hollow  
stainless

03-129  
Hollow  
stainless

03-130  
Hollow

03-131  
Hollow





# TWEEZERS

Précettes - Brucelles  
Пинцеты

Pinzas para algodón  
Пінцети

Zahnpinzetten



Thums



03-191  
15 cm  
Fig. 1  
Thums



03-192  
15 cm  
Fig. 2  
Thums



03-193  
16 cm



Suture



03-194  
15 cm  
Fig. 1  
Suture



03-195  
15 cm  
Fig. 2  
Suture



03-196  
11.5 cm  
Fig. 1

## Micro Surgery Instrument



03-197  
18 cm  
Fig. 1



03-198  
18 cm  
Fig. 2



03-199  
18 cm  
Fig. 3



03-200  
18 cm  
Fig. 4





## PLASTER FOR KNIVES / WIRE CUTTERS

Couteaux a platre  
Ножи для гипса / кусачки

Cuchillos para yeso  
Ножі для гіпсу / кусачки

Gipsmesser / Gisschneide- U. Gipsbrechzange



03-846  
Fig. 1  
17 cm



03-847  
Fig. 2  
Gritman  
17 cm



03-848  
Fig. 3  
16 cm



03-849  
Fig. 4  
16 cm



03-850  
Special Inox  
19.5 cm





## ALGINATE & PLASTER SPATULAS

Spatules a alginate et a platre  
шпатель для альгината и гипса

Espatulas para alginato y para yeso  
шпатель для альгината i гипсу

Alginat- und Gipsspatel



03-851  
Fig. 1  
18.5 cm



03-852  
Fig. 2  
18 cm



03-853  
Fig. 3  
18.5 cm



03-854  
Fig. 4  
19.5 cm



03-855  
Fig. 5  
21.5 cm



03-856  
Fig. 6  
20.5 cm



Spatules a alginate et a platre  
шпатель для альгината и гипса

Espatulas para alginato y para yeso  
шпатель для альгината i гипсу

Alginat- und Gipsspatel



03-857  
Fig. 7  
19.5 cm

03-858  
Fig. 8  
20 cm

03-859  
Fig. 9  
22.5 cm





## RETRACTORS - MOUTH GAGS

Ecarteurs - Ouvre-bouches

Преддверия устройство / зажим рот

Vestibulumabhalter / Mundspanner

Separadores - Abre-bocas

Ретрактори Роторозширювачі



**04-134**  
Mouth Gag Molt  
11 cm for (Children)



**04-135**  
Mouth Gag Molt  
14 cm for (Adults)

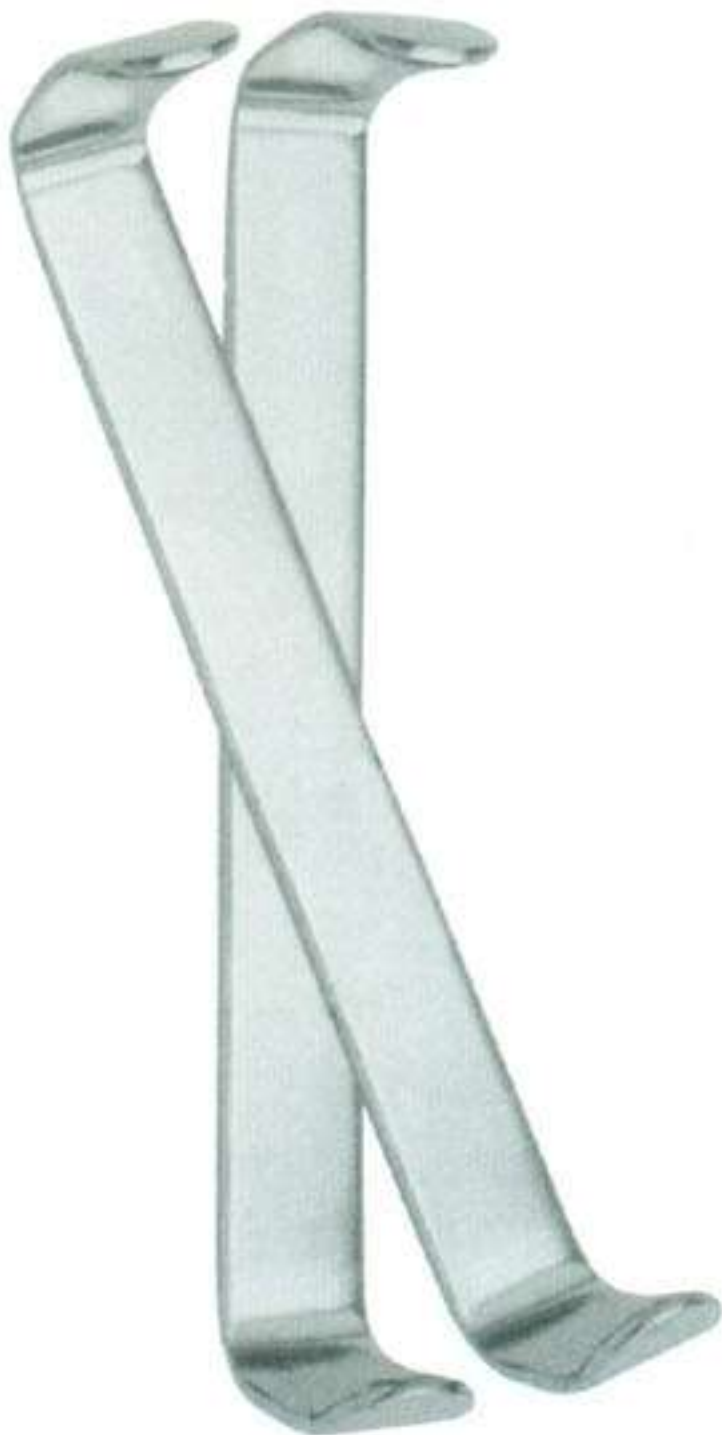

**04-136**  
Farabeuf  
(120 X 12mm  
Set of 2 pices)



**04-137**  
Minnesota university  
140 mm



**04-138**  
Retractor Seldin



**04-139**  
FELDMAN  
RETRACTOR  
5-1/2", 14cm





## TONGUE HOLDING FORCEPS

Tongue Davier  
Язык проведения щипцы

Lengua pinzas de sujeción  
Мова проведення щипці

Zungenzangen



**RUSSIAN TISSUE FORCEPS**  
04-140 6", 15cm  
04-141 8", 20cm



**MAGILL FORCEPS**  
04-142 Child – 7-1/2", 19cm  
04-143 Adult – 9 3/4", 25cm

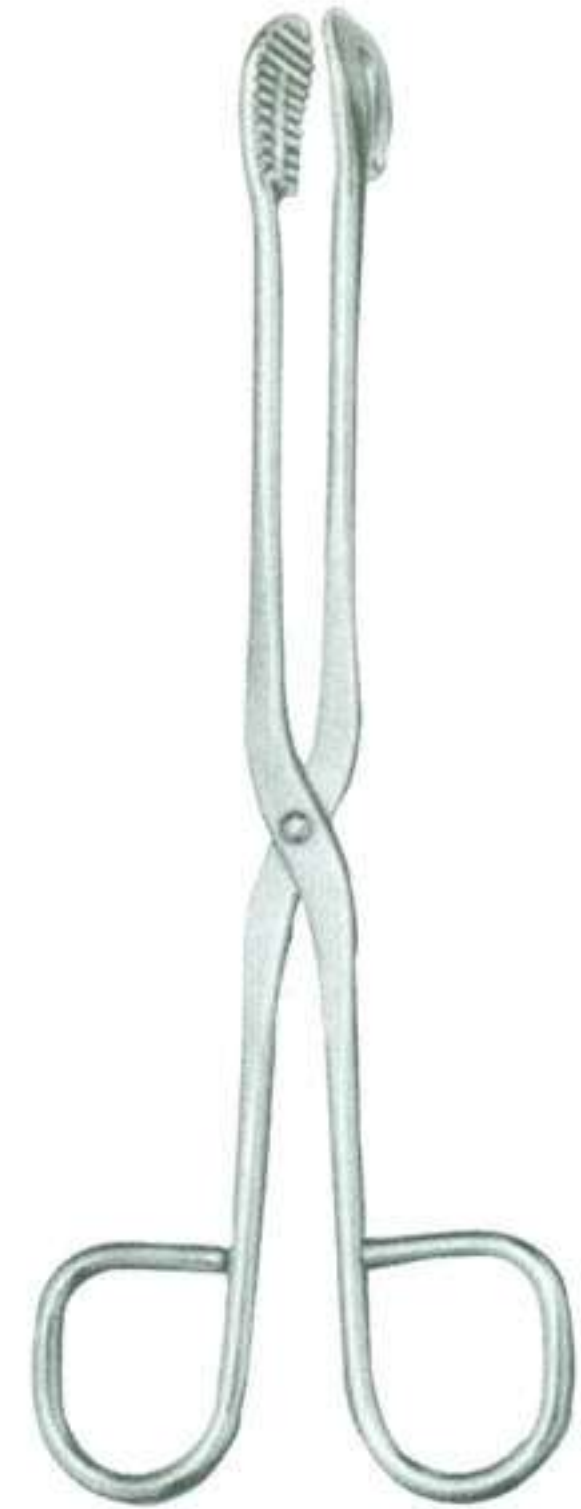

**STERILIZING FORCEPS**  
04-144 Straight, 8", 20cm



**YOUNG TONGUE SEIZING FORCEPS**  
04-145 With Rubber Jaws,  
6-1/4", 16cm  
04-146 Replacement Tips 2/set



**CHISELS**  
04-147  
5mm Flat Chisel,  
45° Angle, 6", 15cm





## GUM SCISSORS

Ciseaux a gencives  
ножницы десневые

Tijeras para encias  
Ножиці для ясен

Zahnfleischscheren



**04-182**  
Goldman Fox Scissors  
12.5cm Curved  
Serrated For Slip-Free Cutting



**04-183**  
Iris Scissors  
11.5cm Curved  
Serrated For  
Slip-Free Cutting



**04-184**  
LaGrange Scissors  
11.5cm Double Curved  
Serrated For Slip-Free Cutting

Double  
Curved



**04-185**  
Castroviejo Micro Scissors  
12cm Curved



**04-186**  
Super Cut Goldman Fox  
13.2cm Curved  
Serrated For  
Slip-Free Cutting



**04-187**  
Super Cut Iris  
11cm Straight  
Serrated For  
Slip-Free Cutting



**04-188**  
Super Cut Iris  
11cm Curved  
Serrated For  
Slip-Free Cutting

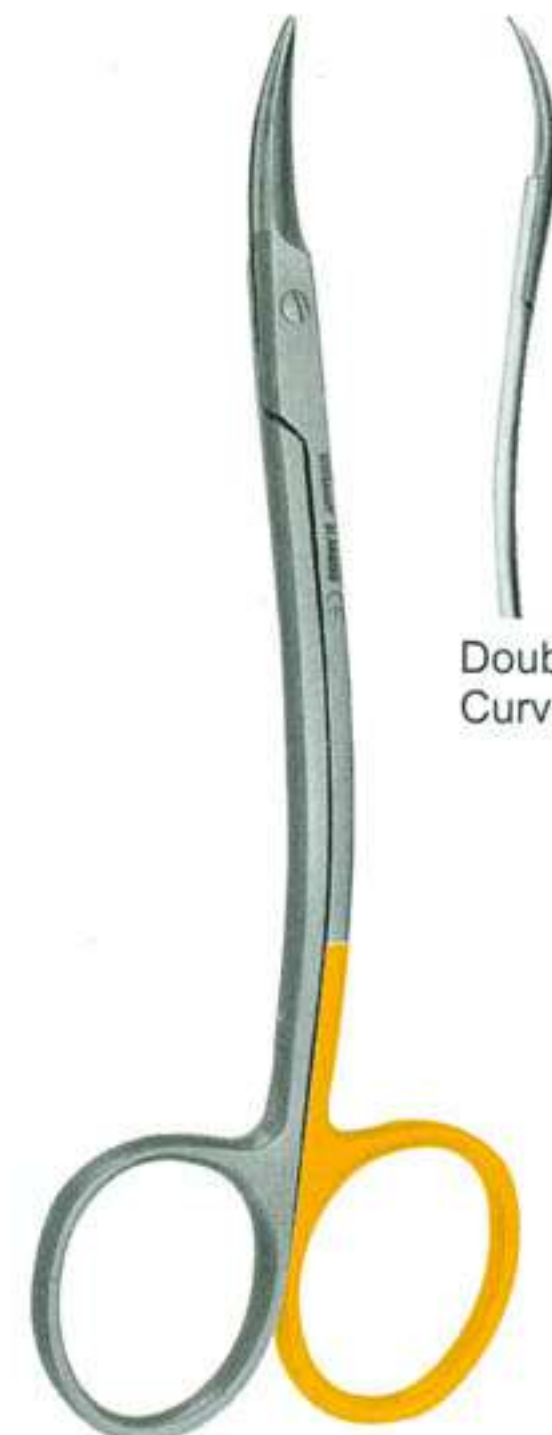

**04-189**  
Super Cut LaGrange  
11.5cm Double Curved  
Serrated For  
Slip-Free Cutting

Double  
Curved





# NEEDLE HOLDERS

Porte-aiguilles      Porta-agujas  
Иглодержатели      Голкотримачі  
Nadelhalter



**04-223**  
Side Cutting Mayo Hegar  
Carbide Tipped With Scissors  
15.3 cm



**04-224**  
Per Peri Needle Holder  
Serrated Carbide tips  
12.7cm  
Delicate Serrated



**04-225**  
Crile Wood Needle Holder  
Curved Serrated Carbide Tip  
15.3cm



**04-226**  
Mini-Gillies Scissors/  
Needle Holder  
Serrated Carbide tips 14cm  
Offset Handle Reduces Hand Fatigue



**04-227**  
Olsen Hegar Scissors/  
Needle Holder  
Serrated Carbide tips  
14cm



**04-228**  
Olsen Hegar Scissors/  
Needle Holder  
Serrated Carbide tips  
16.5cm





# NEEDLE HOLDERS

Porte-aiguilles  
Иглодержатели  
Nadelhalter

Porta-agujas  
Голкотримачі



Serrated Carbide Tips

**04-229**  
Crile Wood Needle Holder  
Serrated Carbide Tip  
15.3cm



Serrated Carbide Tips

**04-230**  
Mayo Hegar Needle Holder  
Serrated Carbide Tip  
15.3cm



Serrated Carbide Tips

**04-231**  
Derf Needle Holder  
Serrated Carbide Tip  
12.1cm



**04-232**  
Halsey  
13 cm



**04-233**  
Crile-Wood  
15 cm



**04-234**  
Mayo-Hegar  
16 cm



**WIRE TWISTERS**  
**04-235** Wire Twister, Blunt – 6", 15cm  
**04-236** Wire Twister, Blunt, TC – 6", 15cm





# NEEDLE HOLDERS

Porte-aiguilles      Porta-agujas  
Иглодержатели      Голкотримачі  
Nadelhalter

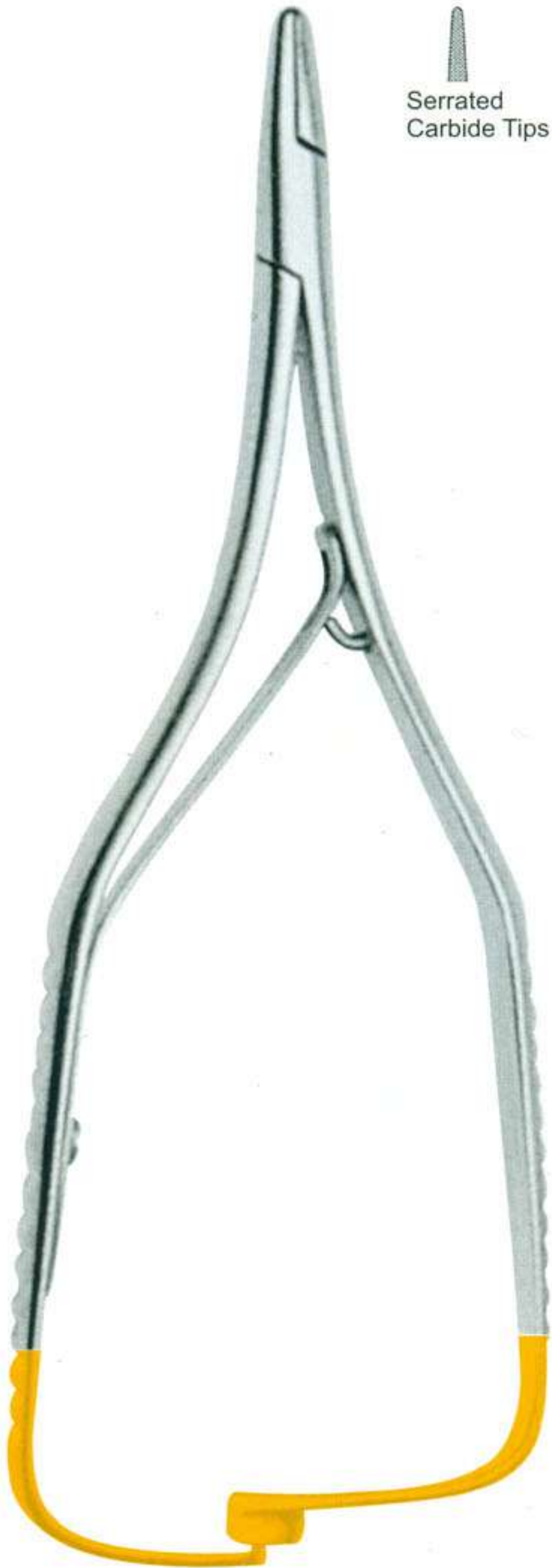

Serrated  
Carbide Tips

**04-237**  
Boynton Needle Holder  
Serrated Carbide Tip  
"Squeeze Through"  
Quick Release  
Delicate Tips 12cm



**04-238**  
Mathieu 17 cm

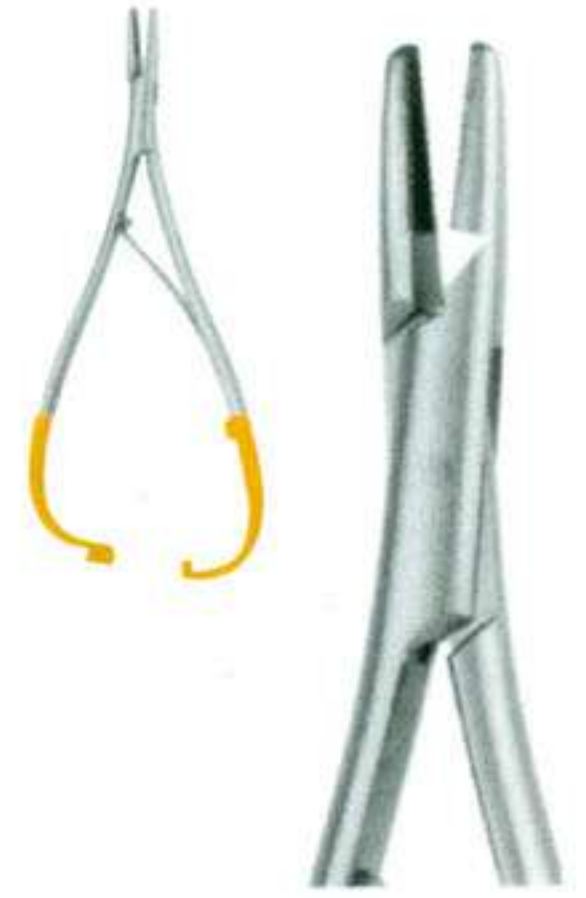

**04-239**  
Mathieu 14 cm



**04-240**  
Mathieu 14 cm

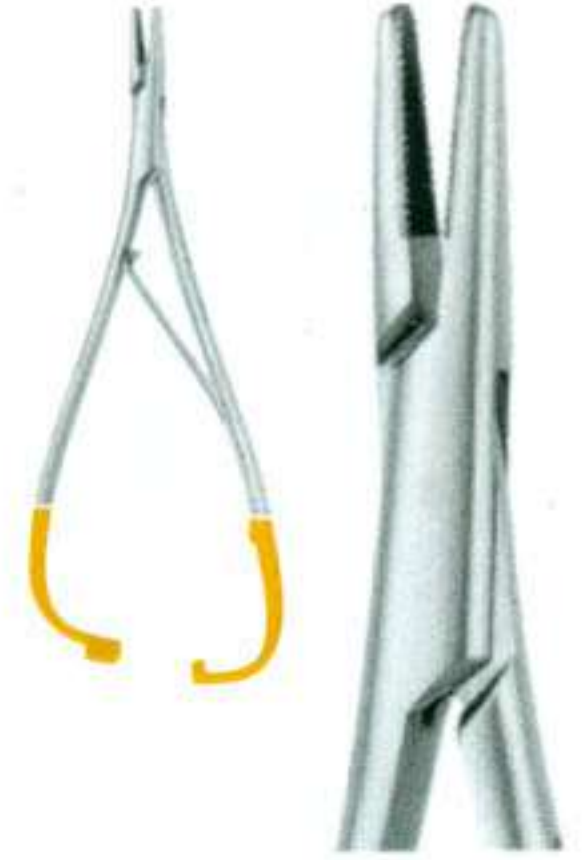

**04-241**  
Mathieu 17 cm





## CROWN REMOVERS

Arrache-couronnes  
щипцы для Телескопических коронок

Arranca-corona  
щипці для телескопічних коронок

Teleskopkronenzangen



**04-345**  
Morrel  
Complete with 3 tips

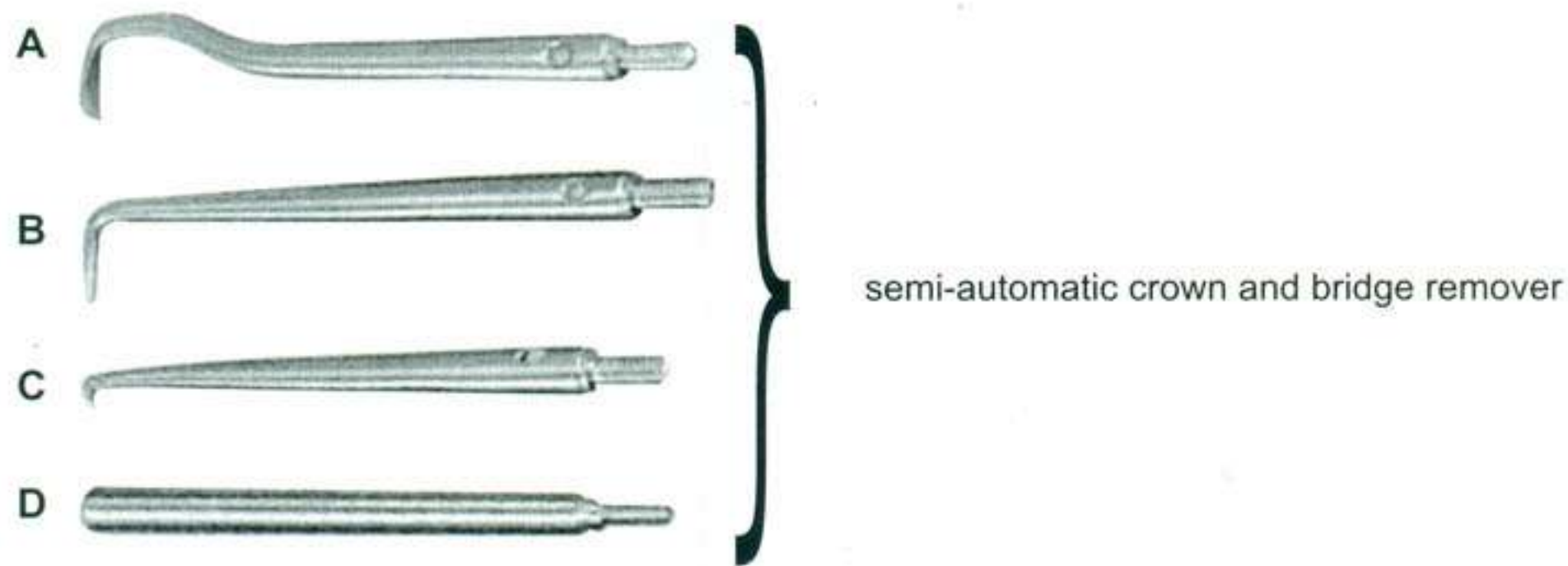

**04-346**  
Complete with 3 tips and tightening keys

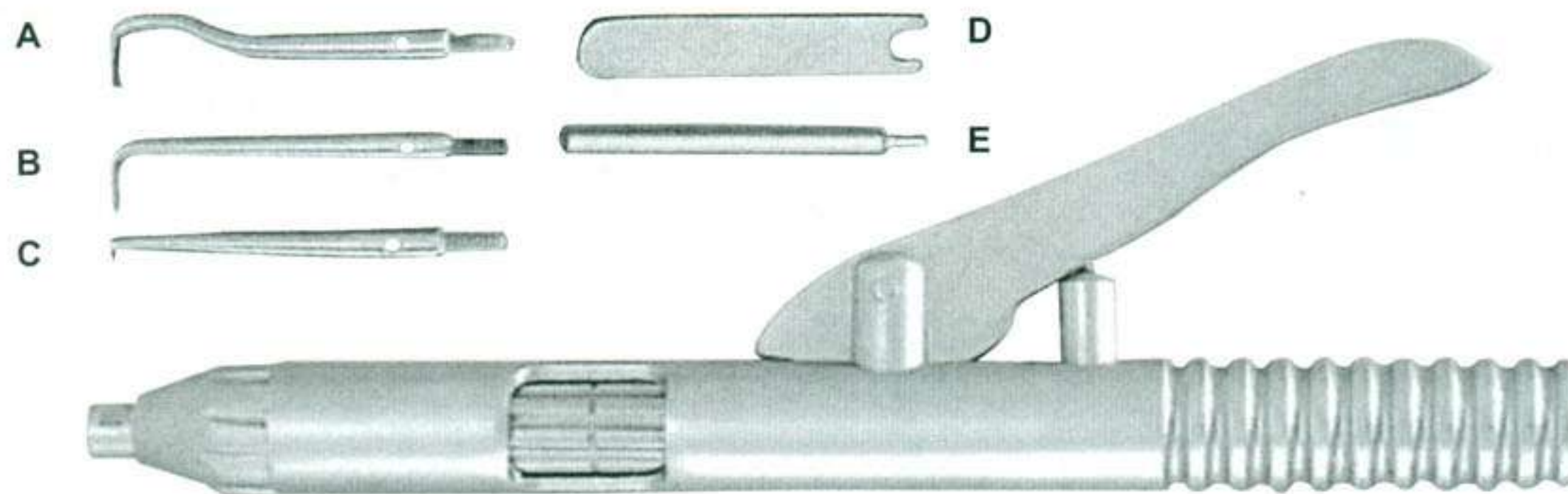

**04-347**  
Complete with 3 tips and mounting kit





# ORTHODONTIC INSTRUMENTS

Instrumentos Ortodonticos  
Ортодонтия инструменты

Instruments Orthodontiques  
Ортодонтия інструменти

Orthodontische Instrumente

## Bracket Holder Tweezers



**05-108**  
Deluxe Bracket  
Holder Tweezers



**05-109**  
Deluxe Bracket  
Holder Tweezers



**05-110**  
Direct Bond Bracket  
Holder Tweezers



**05-111**  
Bracket Tweezers  
Slot Aligner



**05-112**  
Direct Bond  
Bracket Holder  
Tweezers, Small Tip



**05-113**  
Exact Bracket  
Holder Tweezers



**05-114**  
Bracket Placing  
Tweezes



**05-115**  
Easy Access  
Tweezes





# ORTHODONTIC INSTRUMENTS

Instrumentos Ortodonticos  
Ортодонтия инструменты

Instruments Orthodontiques  
Ортодонтия інструменти

Orthodontische Instrumente

## Caliper / Calipers Rule



05-116  
Delux Boley  
Gauge



05-117  
Boley Gauge



05-118  
Beerendonk  
130mm  
Mini Gauge



05-119  
Boley Gauge  
130mm



05-120  
Bone Bracket Gauge



05-121  
for .018" slot  
Bracket positioning  
Gauges



05-122  
for .022" slot  
Bracket positioning  
Gauges

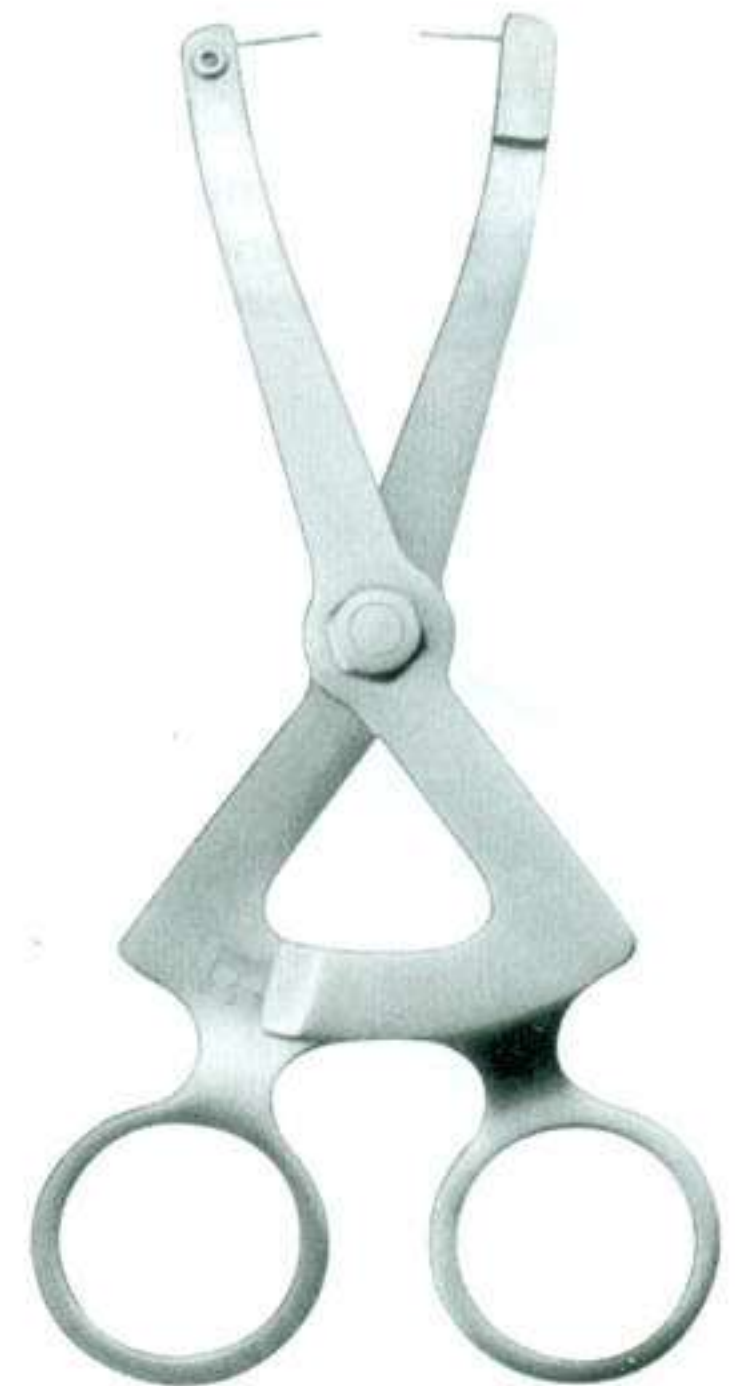

05-123  
**OSTEOMETER**  
Measuring Forceps For Jaw Ridge Width  
measurement, scale on both sides,  
rustfree, autoclavable



Instrumentos Ortodonticos  
Ортодонтия инструменты

Instruments Orthodontiques  
Ортодонтия інструменти

Orthodontische Instrumente

Caliper / Calipers Rule



**05-124**  
Iwanson 100mm  
Decimal Spring Caliper  
for Metal and Porcelain



**05-125**  
Iwanson 100mm  
Decimal Spring Caliper  
for wax



**05-126**  
Ridge Mapping  
Double Caliper



**05-127**  
Fig. 5  
Castroviejo  
18cm 7"



**05-128**  
Fig. 4  
Castroviejo  
18cm 7"



**05-129**  
Fig. 3  
Castroviejo  
18cm 7"



**05-130**  
Fig. 2  
Castroviejo  
18cm 7"



**05-131**  
Fig. 1  
Castroviejo  
18cm 7"





# ORTHODONTIC INSTRUMENTS

Instrumentos Ortodonticos  
Ортодонтия инструменты

Instruments Orthodontiques  
Ортодонтия інструменти

Orthodontische Instrumente



**05-132**  
Ortho light scaler  
double ended



**05-133**  
Ortho light scaler  
double ended



**05-134**  
Ortho light scaler  
double ended



**05-135**  
Twiel-on elastic  
module instrument



**05-136**  
Twiel-on elastic  
module instrument



**05-137**  
Schure Band  
Seater



**05-138**  
Ortho light  
scaler



**05-139**  
Ortho light  
scaler





# ORTHODONTIC INSTRUMENTS

Instrumentos Ortodonticos  
Ортодонтия инструменты

Instruments Orthodontiques  
Ортодонтия інструменти

Orthodontische Instrumente



05-157 Band seater auto cleavable



05-158 Band seater auto cleavable



05-159 Ortho instrument



05-160 Heavy duty band pusher



05-161 Positive Positioner



05-162 Polar Bear Ice Instruments



05-163 Distal Bender





# PLIERS FOR ORTHODONTICS & PROSTHETICS

Pinces pour l'orthodontie et la prothèse  
щипцы для протезирования и ортодонтия  
Zangen für Kieferorthopädie und Prothetik

Alicates para ortodoncia y prótesis  
щипці для протезування та ортодонтія

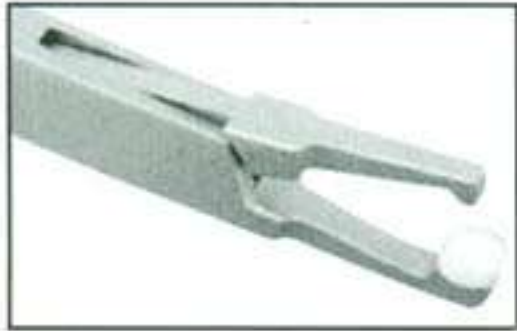

**05-164**  
Bracket Removing Pliers

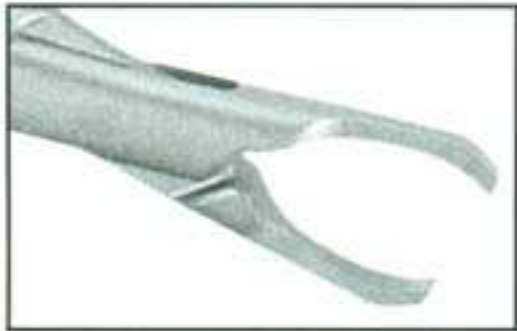

**05-165**  
Bracket Removing Pliers



**05-166**  
Band removing pliers

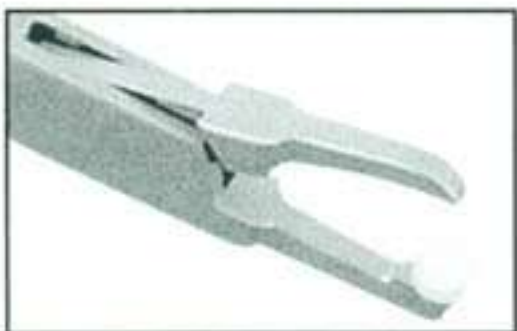

**05-167**  
Band removers curved, Left and Right  
Curved tips provide easy access and grip of band without excess retractor of cheek or lips



**05-168**  
Left



**05-169**  
Right  
Pliers for Bands



**05-170**  
Johnson  
Contouring Pliers

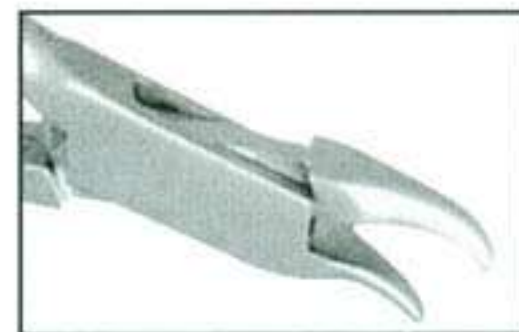

**05-171**  
Reynolds  
Contouring Pliers



**05-172**  
For band seating



**05-173**  
for incisors with convex beaks



**05-174**  
For bicuspids and molars  
with concave beaks







# PLIERS FOR ORTHODONTICS & PROSTHETICS

Pinces pour l'orthodontie et la prothèse  
щипцы для протезирования и ортодонтия

Alicates para ortodoncia y prótesis  
щипці для протезування та ортодонтія

Zangen für Kieferorthopädie und Prothetik



**05-175**  
Straight  
Pliers ball hook crimping



**05-176**  
Angled  
Pliers ball hook crimping



**05-177**  
Micro distal end cutters T.C  
with safety hold

- Max. 0.30 mm to 0.50 mm (.012" to .020")
- Max. 0.46 mm to 0.64 mm (.018" to .025")
- ⊗ Max. 0.38 mm to 0.53 mm (.0155" to .0215")
- ⊗ Max. 0.53 mm to 0.64 mm (.021" to .025")



**05-178**  
Mini distal end cutters T.C  
with safety hold

- Max. 0.30 mm to 0.50 mm (.012" to .020")
- Max. 0.46 mm to 0.64 mm (.018" to .025")
- ⊗ Max. 0.38 mm to 0.53 mm (.0155" to .0215")
- ⊗ Max. 0.53 mm to 0.64 mm (.021" to .025")

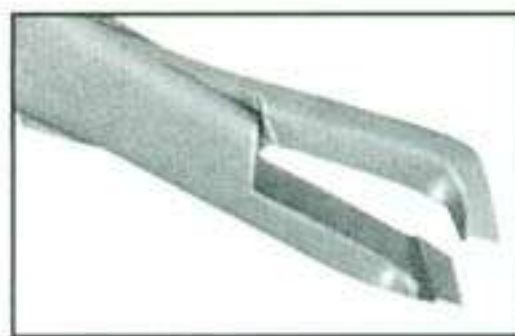

**05-179**  
Mini with long handles T.C  
distal end cutters with safety hold

- Max. 0.30 mm to 0.50 mm (.012" to .020")
- Max. 0.46 mm to 0.64 mm (.018" to .025")
- ⊗ Max. 0.38 mm to 0.53 mm (.0155" to .0215")
- ⊗ Max. 0.53 mm to 0.64 mm (.021" to .025")

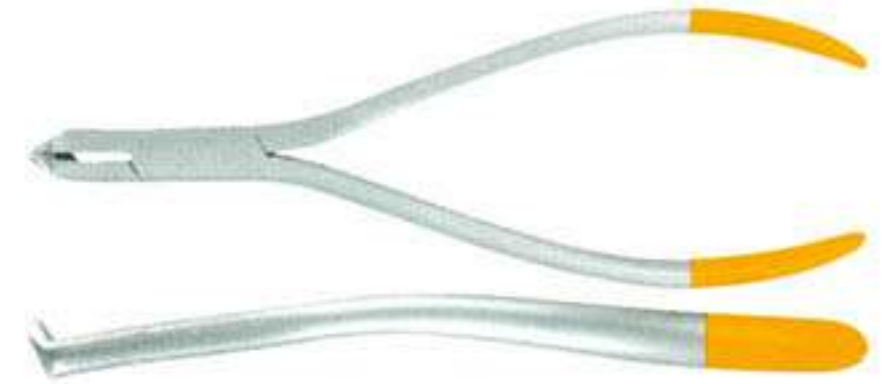

**05-180**  
Mini with extra long off-set handles T.C  
distal end cutters with safety hold

- Max. 0.30 mm to 0.50 mm (.012" to .020")
- Max. 0.46 mm to 0.64 mm (.018" to .025")
- ⊗ Max. 0.38 mm to 0.53 mm (.0155" to .0215")
- ⊗ Max. 0.53 mm to 0.64 mm (.021" to .025")



**05-181**  
Distal end bending pliers

- Max. 0.30 mm to 0.50 mm (.012" to .020")
- Max. 0.56 mm to 0.71 mm (.022" to .028")

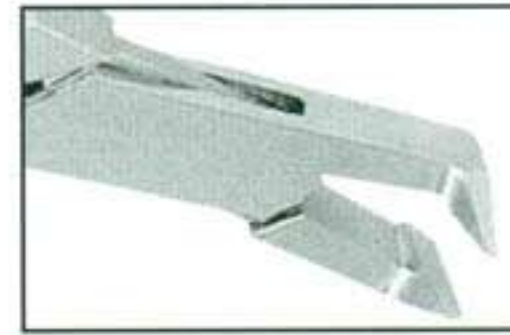

**05-182**  
Weingart mini  
slim design for better accessibility  
in posterior and lingual areas

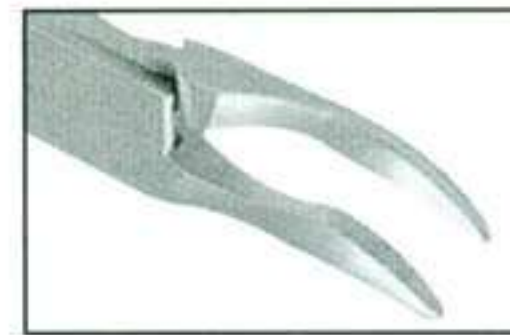

**05-183**  
Weingart Narrow  
Narrow long tips for better  
access to hard to reach areas

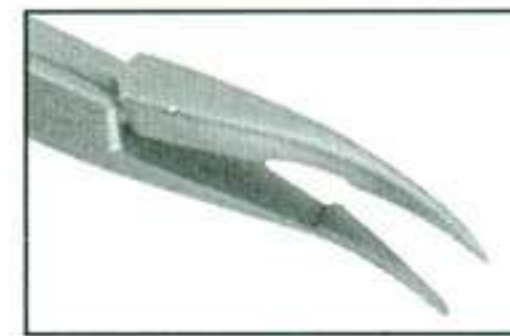

**05-184**  
Weingart Utility Pliers  
Standard

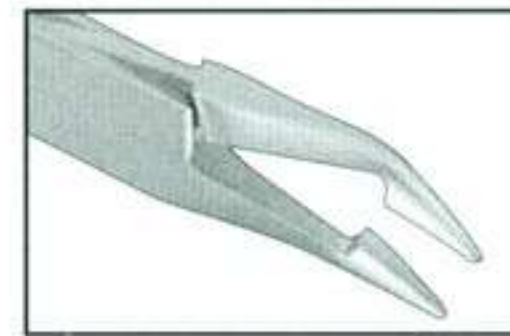





# PLIERS FOR ORTHODONTICS & PROSTHETICS

Pinces pour l'orthodontie et la prothèse  
щипцы для протезирования и ортодонтия  
Zangen für Kieferorthopädie und Prothetik

Alicates para ortodoncia y prótesis  
щипці для протезування та ортодонтія

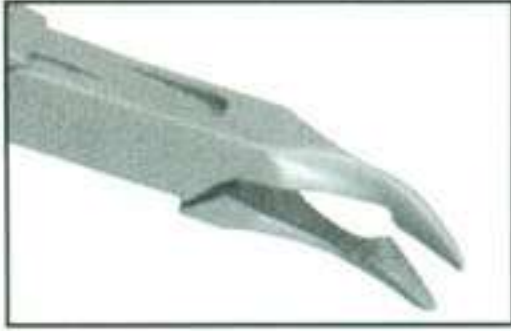

**05-185**  
Weingart Narrow  
Slim and sleek design with long handles, for better access to posterior area, also suitable for lingual technique



**05-186**  
Micro  
Ligature cutters  
.23 mm to .30 mm (.009" to .012")



**05-187**  
Mini  
Ligature cutters  
.25 mm to .38 mm (.010" to .015")

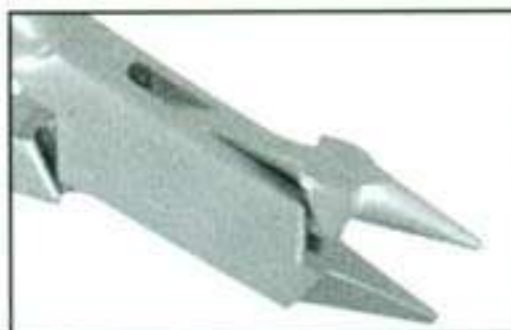

**05-188**  
Wire bending and loop forming pliers  
Angel  
● 0.36 mm to 0.71 mm (.014" to .028")  
■ Max. 0.56 mm x 0.71 mm (.022" to .028")

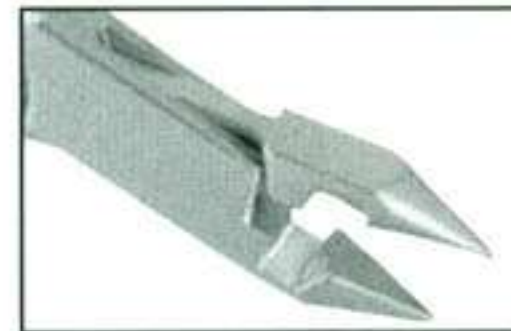

**05-189**  
Wire cutting and loop forming pliers  
Angel  
● 0.36 mm to 0.50 mm (.014" to .020")  
■ Max. 0.41 mm x 0.56 mm (.016" to .022")

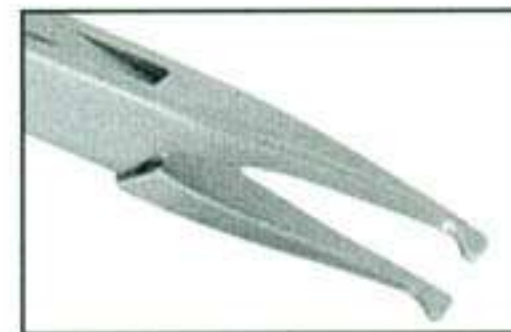

**05-190**  
Straight

How utility pliers  
Standard  
4 mm wide tips

● 0.30 mm to 0.50 mm (.012" to .020")  
■ Max. 0.56 mm x 0.71 mm (.022" to .028")

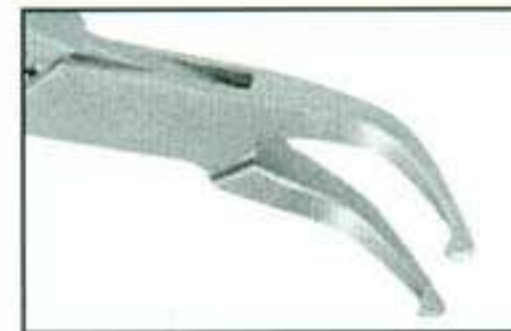

**05-191**  
Angled

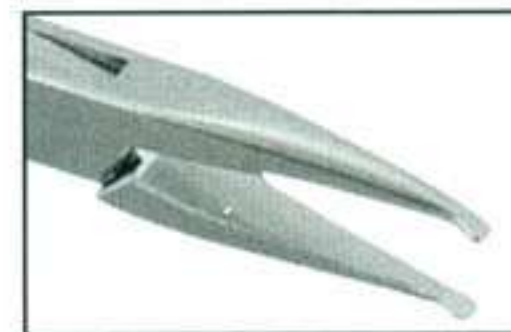

**05-192**  
Straight

How utility pliers  
Mini  
2.4 mm wide tips

● 0.30 mm to 0.50 mm (.012" to .020")  
■ Max. 0.56 mm x 0.71 mm (.022" to .028")



**05-193**  
Angled





# PLIERS FOR ORTHODONTICS & PROSTHETICS

Pinces pour l'orthodontie et la prothèse  
щипцы для протезирования и ортодонтия  
Zangen für Kieferorthopädie und Prothetik

Alicates para ortodoncia y prótesis  
щипці для протезування та ортодонтия

	<p><b>05-194</b> Tweed Loop forming pliers</p> <p>● 0.36 mm to 0.64 mm (.014" to .025") ■ Max. 0.53 mm x 0.64 mm (.021" x .025")</p>	
	<p><b>05-195</b> Tweed Loop forming pliers</p> <p>● 0.36 mm to 0.50 mm (.012" to .020") ■ Max. 0.46 mm x 0.56 mm (.018" x .022")</p>	
	<p><b>05-196</b> Nance Loop forming pliers</p> <p>● 0.36 mm to 0.71 mm (.014" to .028") ■ Max. 0.56 mm x 0.71 mm (.022" x .028")</p>	
	<p><b>05-197</b> De la Rose Arch forming and contouring pliers</p> <p>● 0.36 mm to 0.50 mm (.012" to .020") ■ Max. 0.53 mm x 0.64 mm (.021" x .025")</p>	
	<p><b>05-198</b> Jarabak Light wire bending pliers</p> <p>● 0.36 mm to 0.50 mm (.012" to .022") ■ Max. 0.46 mm x 0.56 mm (.012" x .020")</p>	
	<p><b>05-199</b> Light wire bending and loop forming pliers</p> <p>● 0.36 mm to 0.50 mm (.012" to .020") ■ Max. 0.41 mm x 0.56 mm (.016" x .022")</p>	

	<p><b>05-200</b> Aderer 3-Jaw wire bending pliers</p> <p>● 0.36 mm to 0.76 mm (.014" to .030") ■ Max. 0.56 mm x 0.71 mm (.022" x .028")</p>	
	<p><b>05-201</b> Lingual / Palatal arch forming pliers</p> <p>● 0.76 mm to 0.30 mm (.091" to .036")</p>	
	<p><b>05-202</b> Slim 0.64mm (.025") wide tips arch forming and torquing pliers</p> <p>● 0.36 mm to 0.50 mm (.012" to .020") ■ Max. 0.41 mm x 0.56 mm (.016" x .022")</p>	
	<p><b>05-203</b> Angel 1.27mm (.050") wide tips arch forming and torquing pliers</p> <p>● 0.36 mm to 0.56 mm (.012" to .022") ■ Max. 0.53 mm x 0.64 mm (.021" x .025")</p>	
	<p><b>05-204</b> Tweed / Angel 1.78mm (.070") wide tips arch forming and torquing pliers</p> <p>● 0.36 mm to 0.71 mm (.012" to .028") ■ Max. 0.56 mm x 0.71 mm (.022" x .028")</p>	





# PLIERS FOR ORTHODONTICS & PROSTHETICS

Pinces pour l'orthodontie et la prothèse  
щипцы для протезирования и ортодонтия  
Zangen für Kieferorthopädie und Prothetik

Alicates para ortodoncia y prótesis  
щипці для протезування та ортодонтія



**05-205**  
Mini head distal end cutter with safety hold, long handles fitted with un-breakable, corrosion resistant and durable stainless steel tips

- 0.30 mm to 0.50 mm (.012" to .020")
- Max. 0.46 mm x 0.64 mm (.018" x .025")
- ⊗ 0.38 mm to 0.53 mm (.0155" to .0215")
- ⊗ Max. 0.53 mm x 0.64 mm (.021" x .025")



**05-206**  
Hard wire cutter, 15° angled fitted with un-breakable, corrosion resistant and durable stainless steel tips

- 0.30 mm to 0.50 mm (.012" to .020")
- Max. 0.56 mm x 0.71 mm (.022" to .028")



**05-207**  
Soft wire and ligature cutter, Mini fitted with un-breakable, corrosion resistant and durable stainless steel tips

- ⌋ .25 mm to .38 mm (.010" to .015")



**05-208**  
Band removing pliers



**05-209**  
Band removing pliers with plastic tip



**05-210**  
**Weingart**  
Utility pliers

- 0.30 mm to 0.50 mm (.012" to .020")
- Max. 0.56 mm x 0.71 mm (.022" to .028")



**05-211**  
Standard distal end cutter with safety hold fitted with un-breakable, corrosion resistant and durable stainless steel tips

- 0.30 mm to 0.50 mm (.012" to .020")
- Max. 0.56 mm x 0.71 mm (.022" to .028")

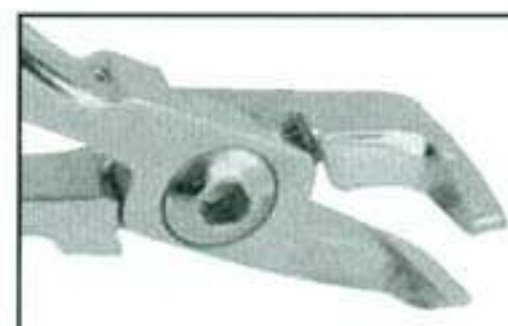

**05-212**  
Mini head distal end cutter with safety hold fitted with un-breakable, corrosion resistant and durable stainless steel tips

- 0.30 mm to 0.50 mm (.012" to .020")
- Max. 0.46 mm x 0.64 mm (.018" x .025")
- ⊗ 0.38 mm to 0.53 mm (.0155" to .0215")
- ⊗ Max. 0.53 mm x 0.64 mm (.021" x .025")





# PLIERS FOR ORTHODONTICS & PROSTHETICS

Pinces pour l'orthodontie et la prothèse  
щипцы для протезирования и ортодонтия  
Zangen für Kieferorthopädie und Prothetik

Alicates para ortodoncia y prótesis  
щипці для протезування та ортодонтія

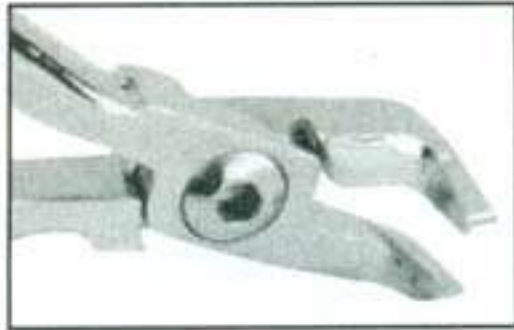

**05-213**  
Distal end cutter with safety hold, mini head, long handles. fitted with un-breakable, corrosion resistant and durable stainless steel tips

- 0.30 mm to 0.50 mm (.012" to .020")
- Max. 0.46 mm x 0.64 mm (.018" x .025")
- ⊗ 0.38 mm to 0.53 mm (.0155" to .0215")
- ⊗ Max. 0.53 mm x 0.64 mm (.021" x .025")



**05-214**  
Flush-cut distal end cutter with safety hold fitted with un-breakable, corrosion resistant and durable stainless steel tips

- 0.30 mm to 0.50 mm (.012" to .020")
- Max. 0.46 mm x 0.64 mm (.018" to .025")

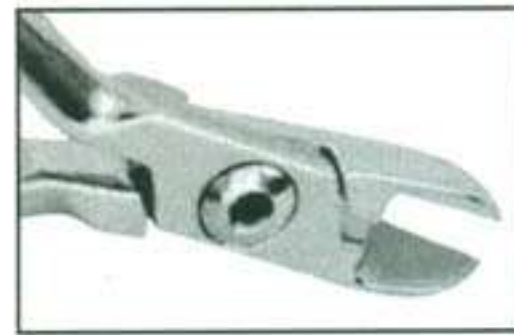

**05-215**  
Soft wire and ligature cutter, Mini fitted with un-breakable, corrosion resistant and durable stainless steel tips

- ⊗ .25 mm to .38 mm (.010" to .015")



**05-216**  
Soft wire and ligature cutter, standard fitted with un-breakable, corrosion resistant and durable stainless steel tips

- ⊗ .25 mm to .38 mm (.010" to .015")



**05-217**  
Soft wire and ligature cutter, 15° angled fitted with un-breakable, corrosion resistant and durable stainless steel tips

- ⊗ .25 mm to .38 mm (.010" to .015")

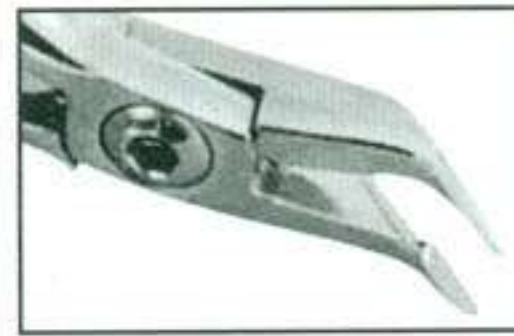

**05-218**  
Soft wire and ligature cutter, 45° angled fitted with un-breakable, corrosion resistant and durable stainless steel tips

- ⊗ .25 mm to .38 mm (.010" to .015")



**05-219**  
Hard wire cutter, straight Fitted with un-breakable, corrosion resistant and durable stainless steel tips

- 0.30 mm to 0.50 mm (.012" to .020")
- Max. 0.56 mm x 0.71 mm (.022" x .028")



**05-220**  
Hard wire cutter, 15° angled Fitted with un-breakable, corrosion resistant and durable stainless steel tips

- 0.30 mm to 0.50 mm (.012" to .020")
- Max. 0.56 mm x 0.71 mm (.022" x .028")



**05-221**  
Hard wire cutter, 15° angled Non-autocalavable

- 0.30 mm to 0.50 mm (.012" to .020")
- Max. 0.56 mm x 0.71 mm (.022" x .028")





# PLIERS FOR ORTHODONTICS & PROSTHETICS

Pinces pour l'orthodontie et la prothèse  
щипцы для протезирования и ортодонтия  
Zangen für Kieferorthopädie und Prothetik

Alicates para ortodoncia y prótesis  
щипці для протезування та ортодонтія

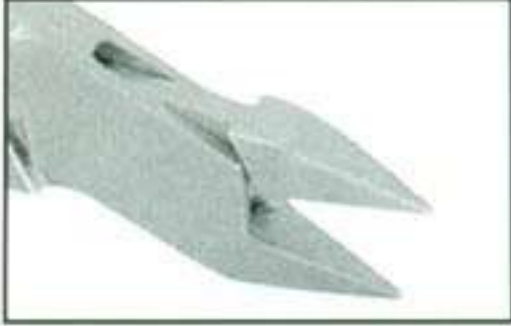

**05-252**  
Adams  
Wire bending pliers

● 0.30 mm to 0.81 mm (.014" to .032")  
■ Max. 0.56 mm x 0.71 mm (.022" x .028")

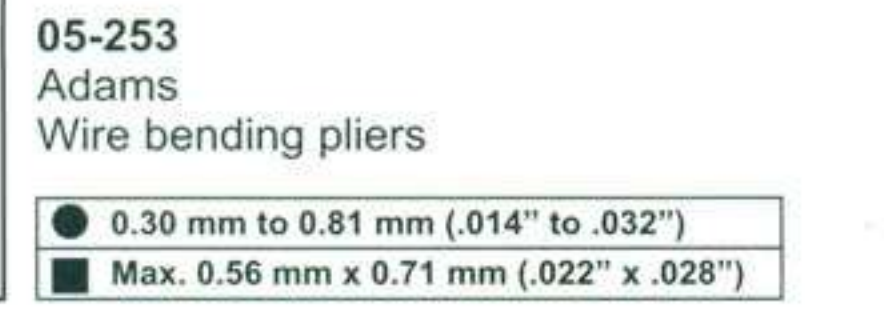

**05-253**  
Adams  
Wire bending pliers

● 0.30 mm to 0.81 mm (.014" to .032")  
■ Max. 0.56 mm x 0.71 mm (.022" x .028")

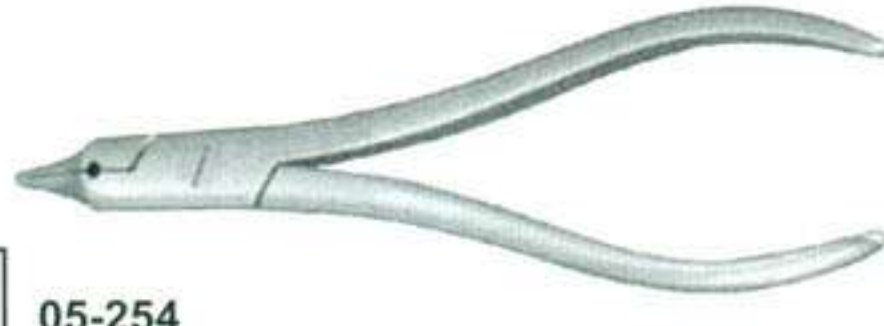

**05-254**  
Universal small  
Wire bending and cutting pliers

● Bends: 0.9 mm (.036")  
Cuts: 0.7 mm (.028")



**05-255**  
Universal Dolphin style  
Wire bending and cutting pliers

● Bends: 0.9 mm (.036")  
Cuts: 0.7 mm (.028")



**05-256**  
Universal Taper style  
Wire bending and cutting pliers

● Bends: 0.9 mm (.036")  
Cuts: 0.7 mm (.028")

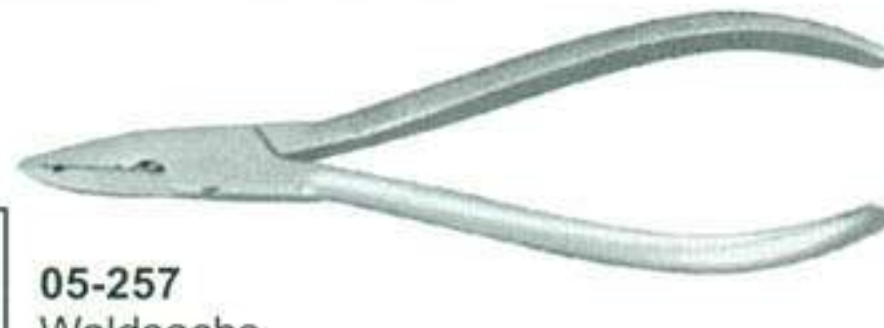
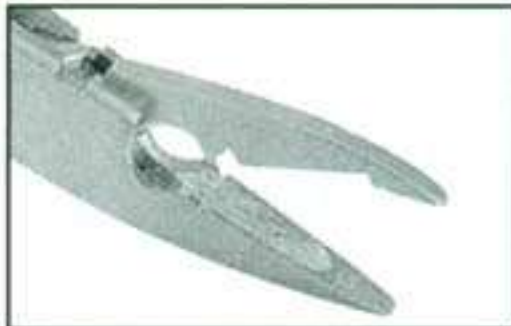

**05-257**  
Waldsachs  
Wire bending and cutting pliers

● Bends: 0.9 mm (.036")  
Cuts: 0.7 mm (.028")



**05-258**  
Hard wire cutters T.C.

● 0.70 mm to 1.00 mm (.028" to .040")

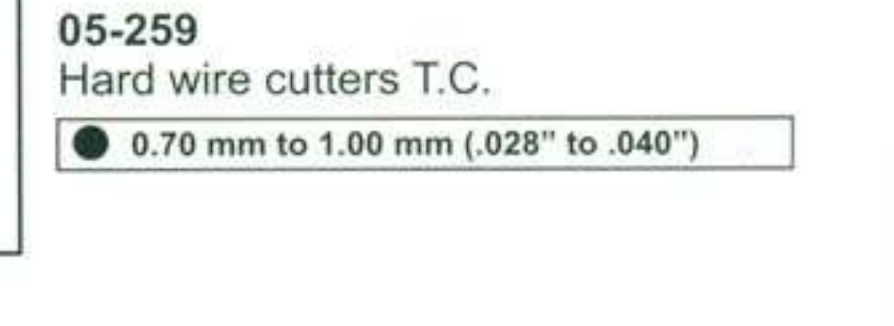
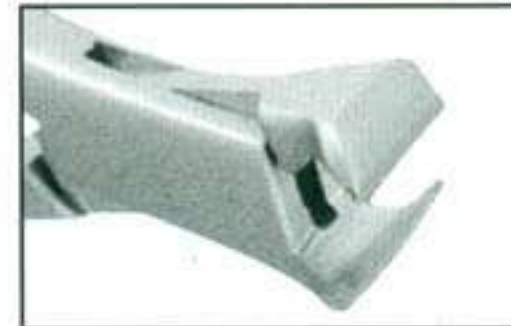

**05-259**  
Hard wire cutters T.C.

● 0.70 mm to 1.00 mm (.028" to .040")



**05-260**  
Hard wire cutters T.C.

● 0.60 mm to 0.80 mm (.024" to .032")

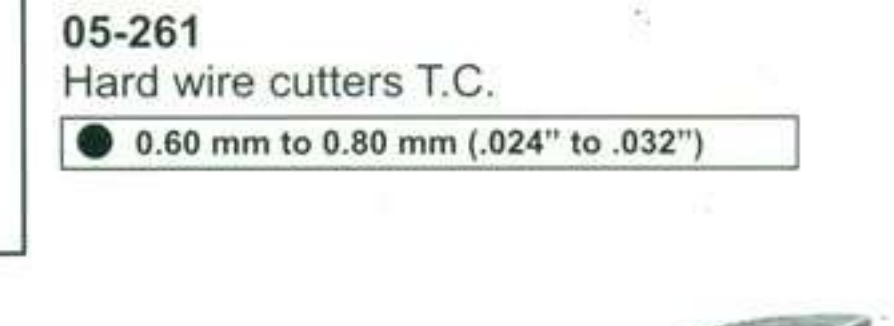
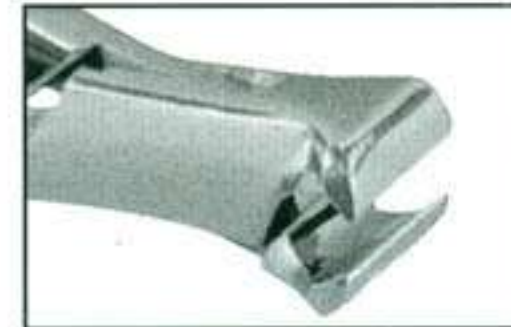

**05-261**  
Hard wire cutters T.C.

● 0.60 mm to 0.80 mm (.024" to .032")



**05-262**  
Hard wire cutters

● 0.87 mm to 1.1 mm (.028" to .045")

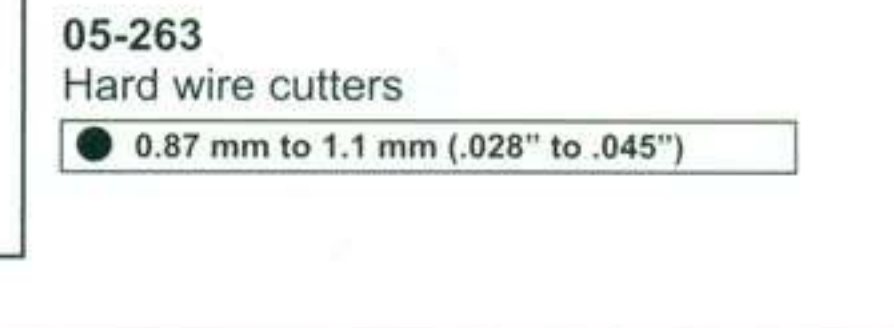
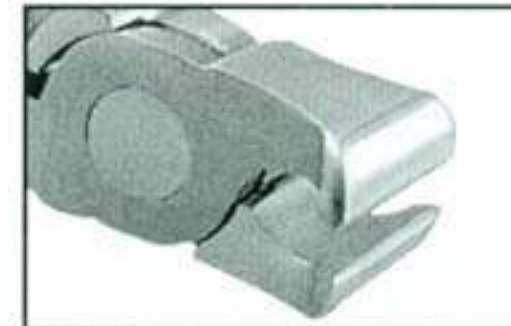

**05-263**  
Hard wire cutters

● 0.87 mm to 1.1 mm (.028" to .045")





# PLIERS FOR ORTHODONTICS & PROSTHETICS

Pinces pour l'orthodontie et la prothèse  
щипцы для протезирования и ортодонтия  
Zangen für Kieferorthopädie und Prothetik

Alicates para ortodoncia y prótesis  
щипці для протезування та ортодонтія

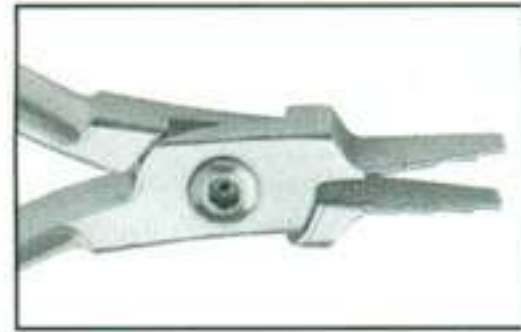

**05-275**  
Loop forming in four length  
3,4,5 & 6 mm wire capacity  
0.22" / 56mm.

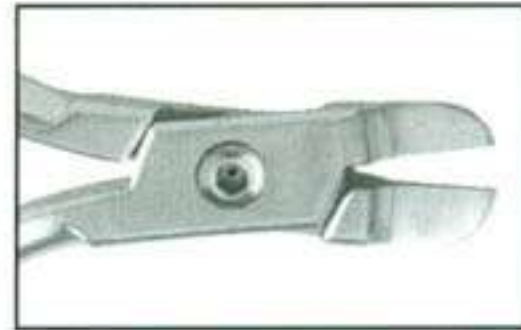
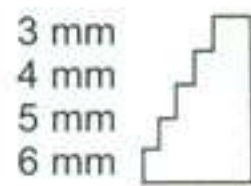

**05-276**  
Arch bending plier design for  
convenient handling of square or  
rectangular wire, .020" / 0.51mm.

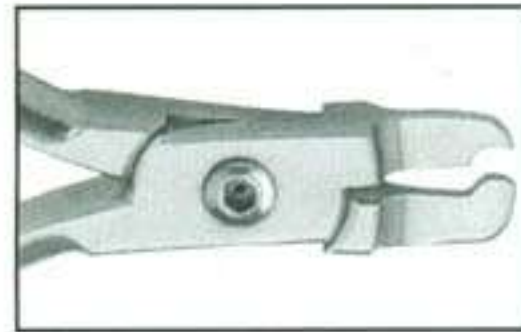

**05-277**  
In order to skirt  
bands and crowns.



**05-278**  
Wires up to  
.020" / 0.7mm.

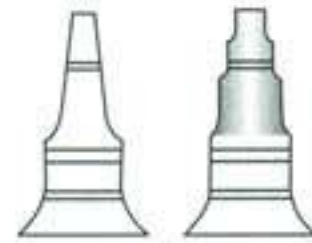

**05-279**  
Round and concave plier  
for loop forming and banding  
wire up to .20" / .051mm.

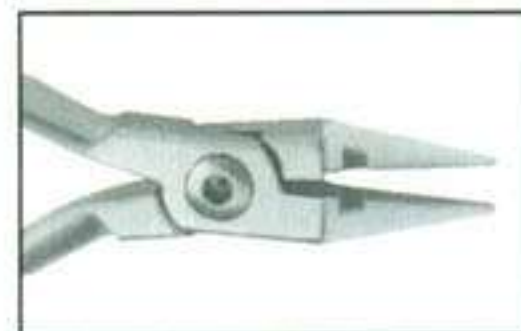

**05-280**  
Bending for round square  
or rectangular wire up  
to 0.30"/0.76mm

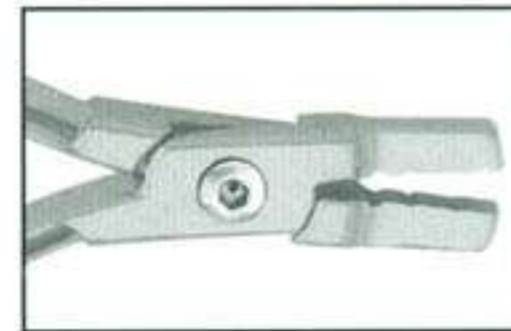

**05-281**  
for double back and triple  
back bands in 0.30" / .76mm  
& 0.36" / .91mm lingual arch wires.

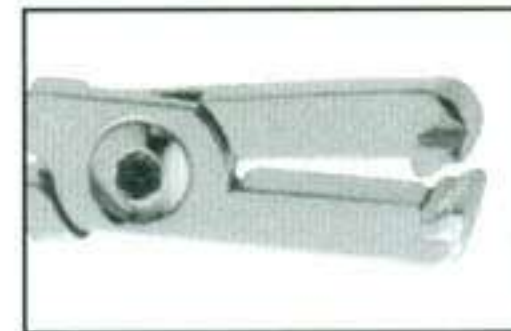

**05-282**  
Detailing step plier double-sided  
offset beak permits bayonet bends.  
Creates right hand or left hand  
step-up or stepdown at 1/2, 3/4, or  
1mm increments.

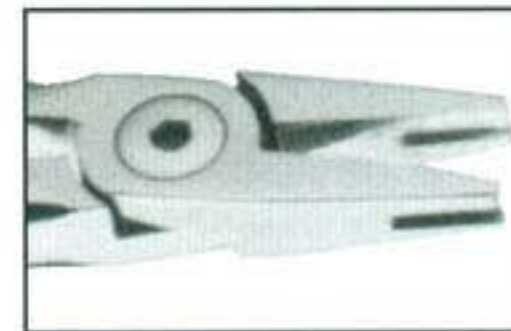

**05-283**  
"V" bend stop special design makes  
1mm "v" bends to shorten archwires  
or provide a positive stop. Excellent  
for placing stops in titanium wires.  
For round or rectangular wires up to .025"

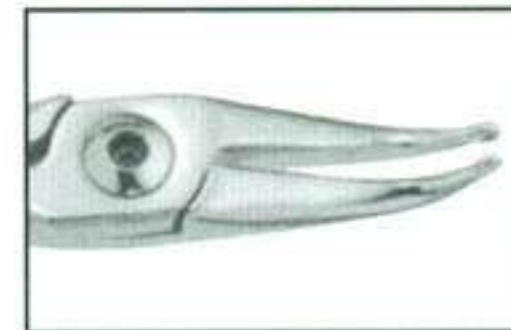

**05-284**  
Angle how plier efficient utility plier  
with serrated beaks for a firm grip.  
45 angled tips to access hard to  
reach areas.

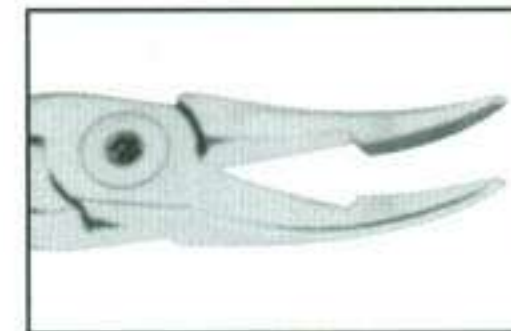

**05-285**  
Weingardt plier serrated tips hold  
wires firmly at a convenient working  
angle. Tapered beaks fit easily  
between brackets and hard to reach  
areas. Our most popular utility plier.





# PLIERS FOR ORTHODONTICS & PROSTHETICS

Pinces pour l'orthodontie et la prothèse  
щипцы для протезирования и ортодонтия

Alicates para ortodoncia y prótesis  
щипці для протезування та ортодонтія

Zangen für Kieferorthopädie und Prothetik

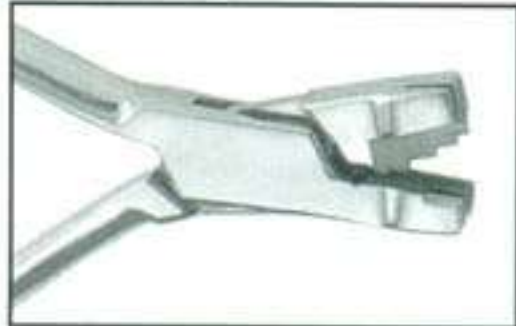

**05-286**  
Nance loop closing plier, for bending of stop loops and adams' clasps.  
Wire up to .022" x .028", 0.7mm.

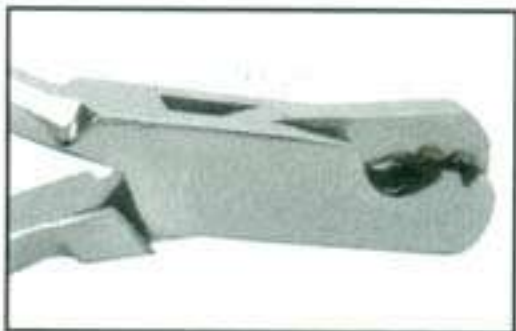
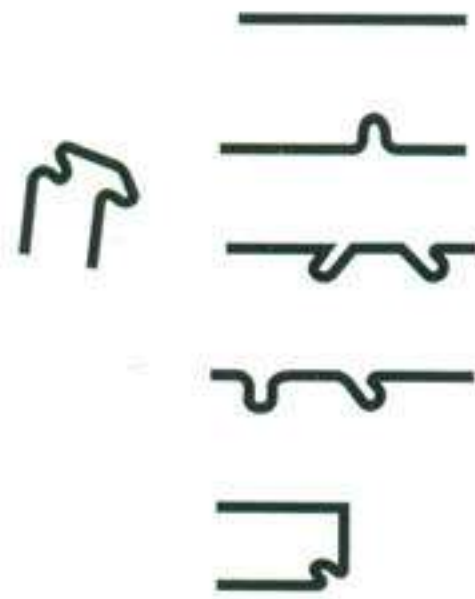

**05-287**  
Plier for double bars.

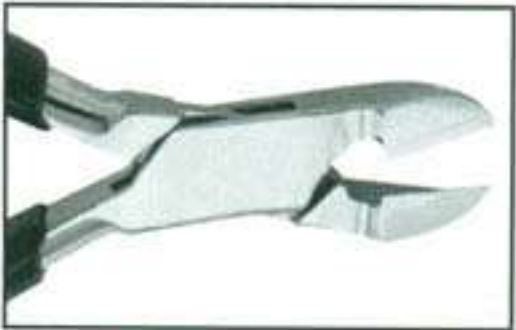

**05-288**  
Hard wire cutter up to .022" x .028" .56mm x 71mm.

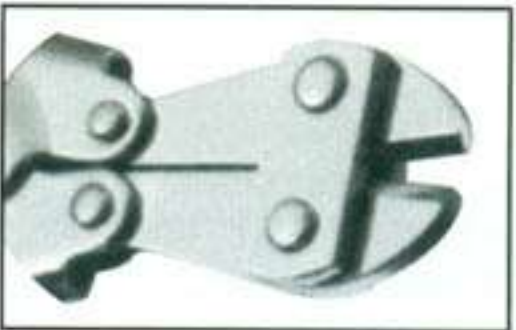

**05-289**  
Heavy duty wire cutter unique joint and extremely sturdy cutting edge make it ideal for cutting face bows and other large diameter wires up to .080".  
This cutter is not autoclavable.



**05-290**  
Extra-heavy wire cutter heavy duty to cut all archwires and retainer wires up to .060".  
An excellent lab plier for cutting heavy retainer wires.

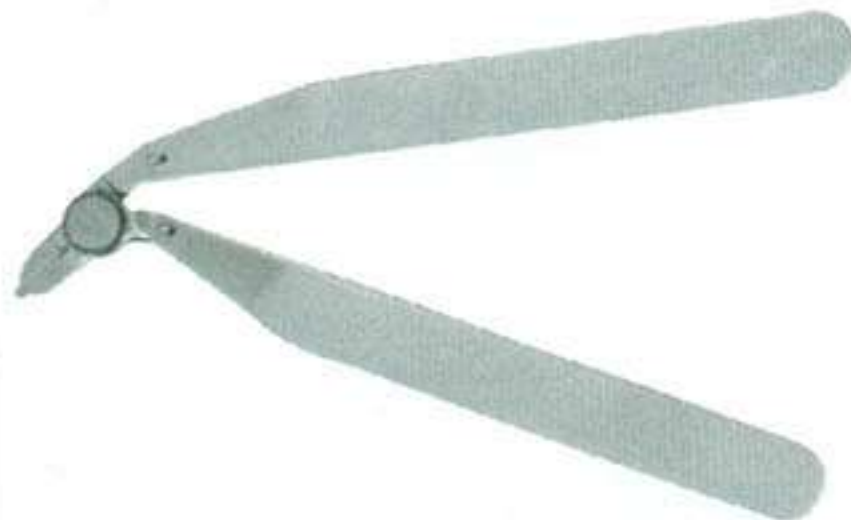

**05-291**  
E-Z Ligature Placer



**05-292**  
T.C  
angled direct bond bracket remover

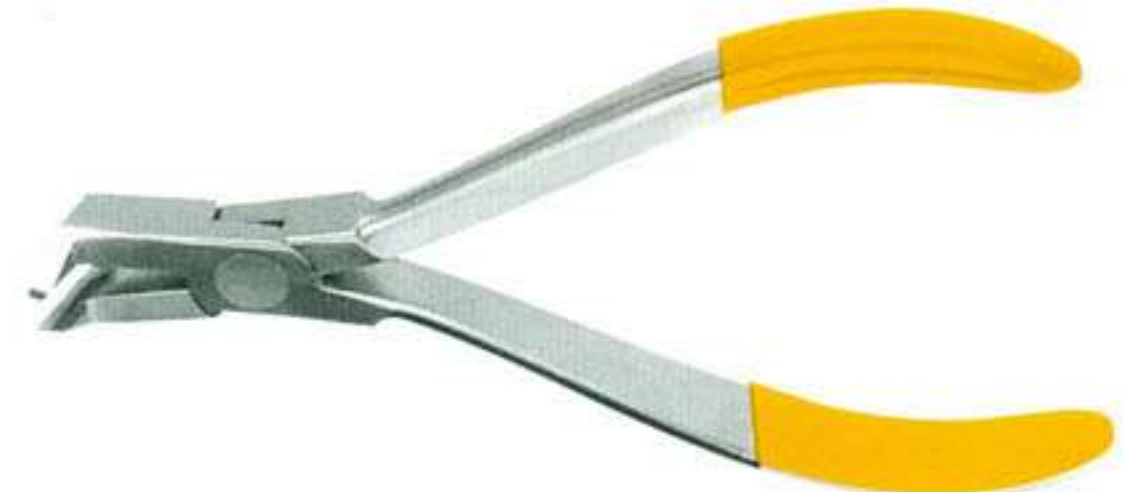

**05-293**  
T.C  
Distal End Cutter  
Safety hold is ideal for cutting wires within the patient's mouth.



**05-294**  
T.C  
Direct bonding bracket remover (wide) plier



**05-295**  
T.C  
Pin and ligature cutter



**05-296**  
T.C  
Direct bracket remover





# IMPRESSION TRAYS

Porte-empainte  
ложки впечатление

Cubetas para impresiones  
Відбиткові ложки

Abdrucklöffel

## Perforated With Rim Lock

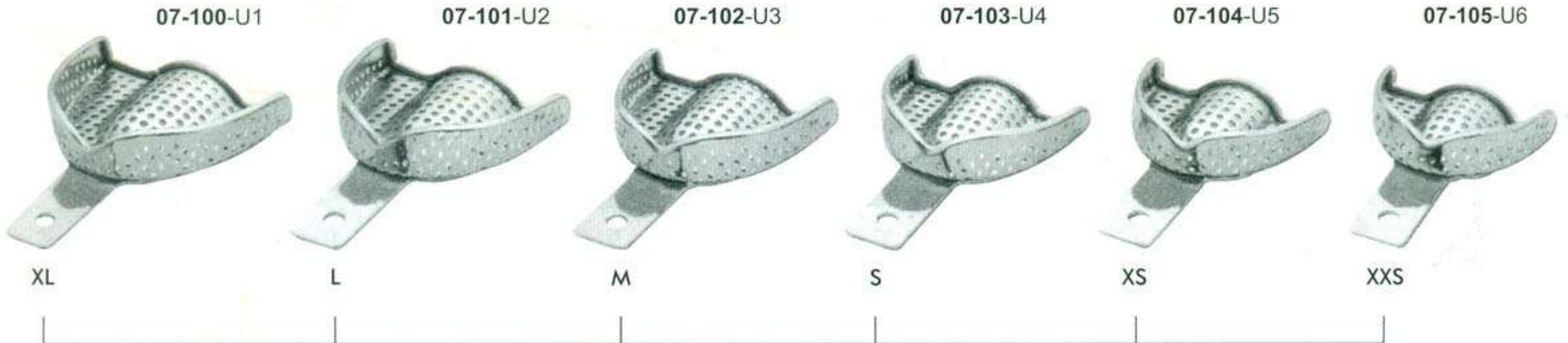

Upper		A (left-right)	B (top-bottom)
07-100-U1	XL	81 mm	63 mm
07-101-U2	L	73 mm	58 mm
07-102-U3	M	71 mm	52 mm
07-103-U4	S	67 mm	53 mm
07-104-U5	XS	65 mm	51 mm
07-105-U6	XXS	61 mm	50 mm

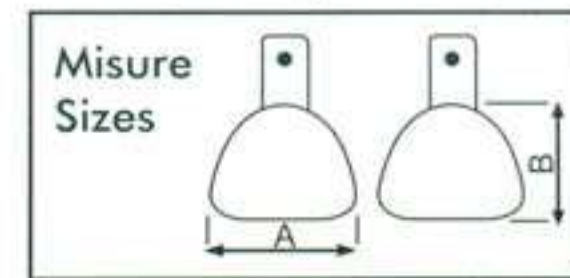

Lower		A (left-right)	B (top-bottom)
07-106-L1	XL	78 mm	63 mm
07-107-L2	L	74 mm	62 mm
07-107-L3	M	72 mm	59 mm
07-109-L4	S	70 mm	57 mm
07-110-L5	XS	69 mm	55 mm
07-111-L6	XXS	59 mm	50 mm

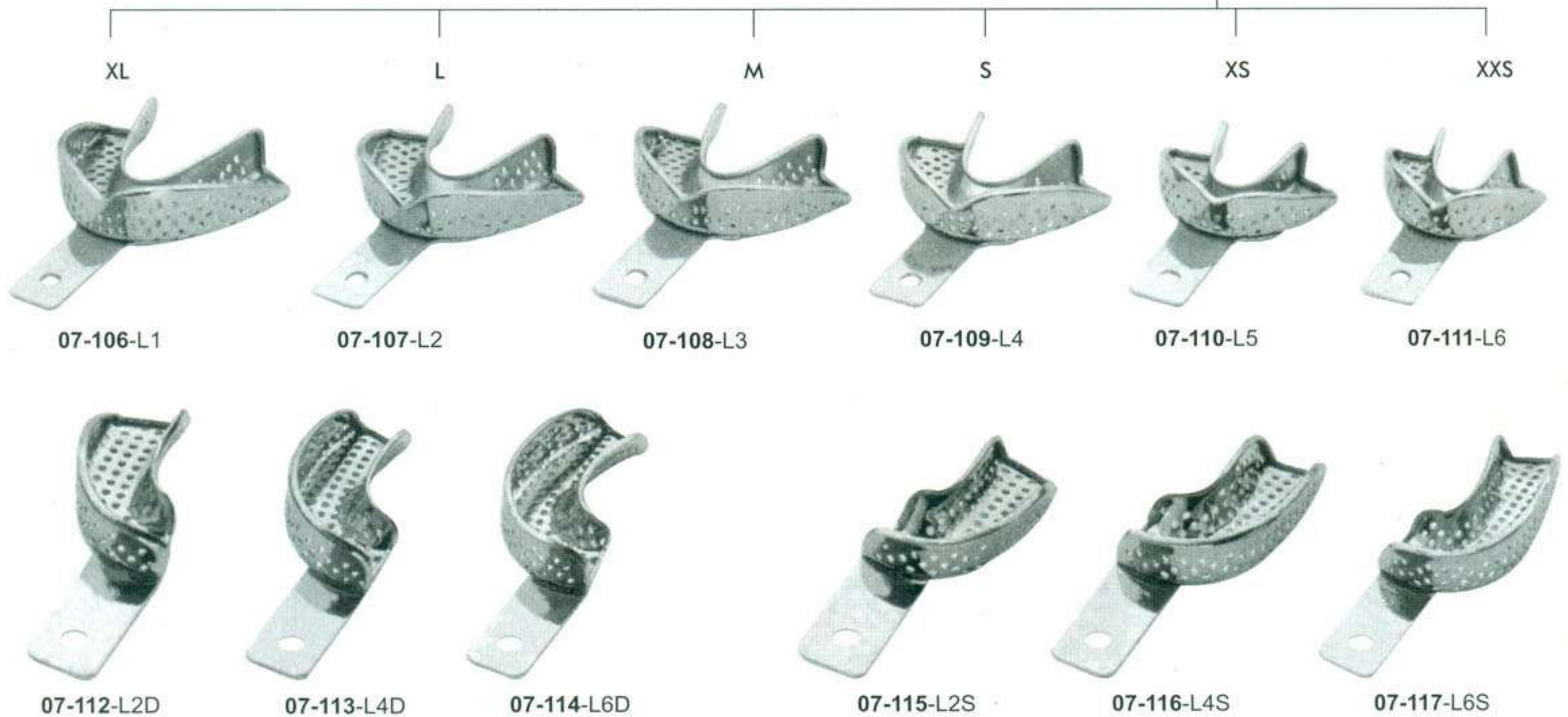
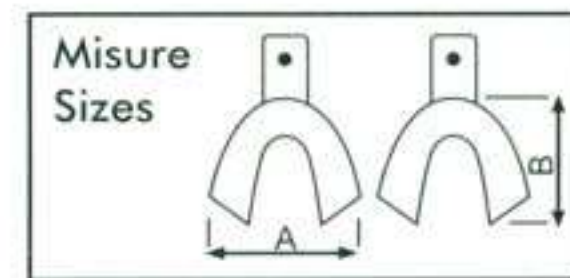





# IMPRESSION TRAYS

Porte-empreinte  
ложки впечатление

Cubetas para impresiones  
Відбиткові ложки

Abdrucklöffel  
Solid With Rim Lock

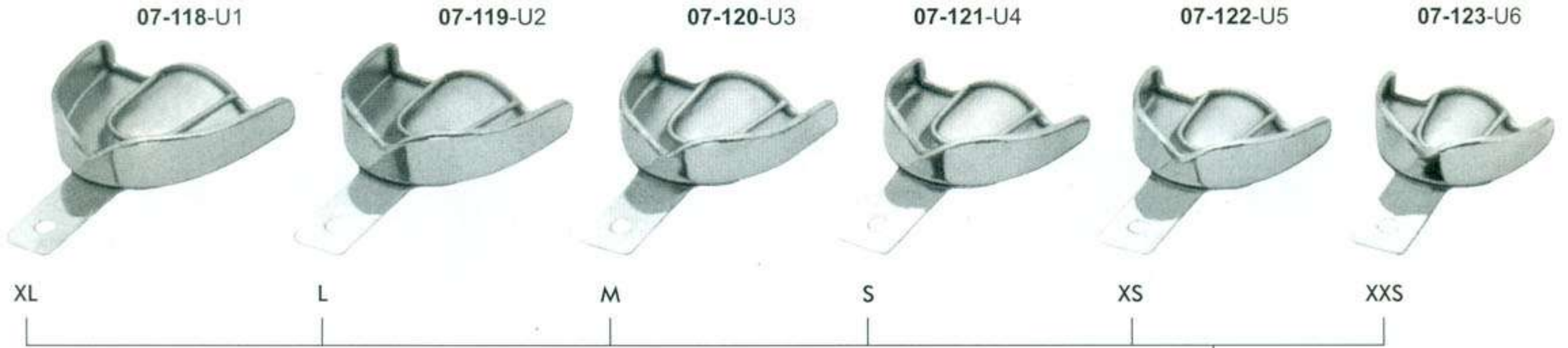

Upper		A (left-right)	B (top-bottom)
07-118-U1	XL	81 mm	63 mm
07-119-U2	L	73 mm	58 mm
07-120-U3	M	71 mm	52 mm
07-121-U4	S	67 mm	53 mm
07-122-U5	XS	65 mm	51 mm
07-123-U6	XXS	61 mm	50 mm

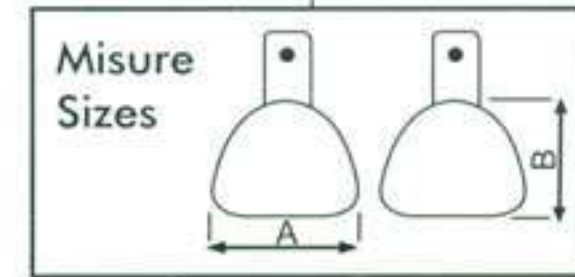

Lower		A (left-right)	B (top-bottom)
07-124-L1	XL	78 mm	63 mm
07-125-L2	L	74 mm	62 mm
07-126-L3	M	72 mm	59 mm
07-127-L4	S	70 mm	57 mm
07-128-L5	XS	69 mm	55 mm
07-129-L6	XXS	59 mm	50 mm

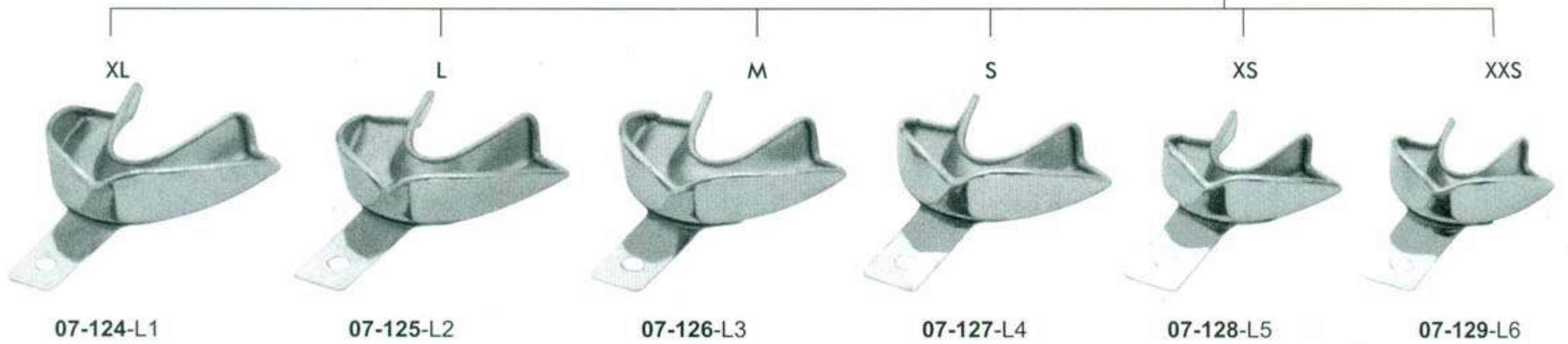
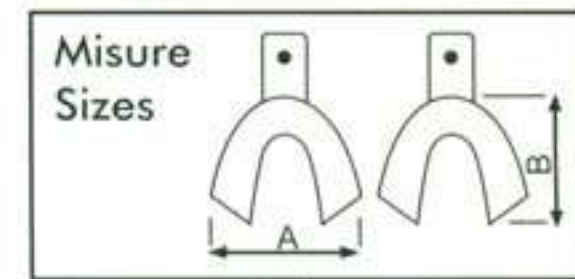

07-124-L1

07-125-L2

07-126-L3

07-127-L4

07-128-L5

07-129-L6



07-130-L2D



07-131-L4D



07-132-L6D



07-133-L2S



07-134-L4S

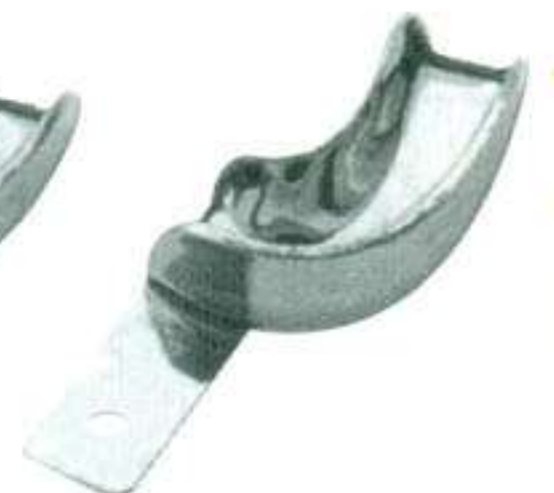

07-135-L6S





# IMPRESSION TRAYS

Porte-empreinte  
ложки впечатление

Cubetas para impresiones  
Відбиткові ложки

Abdrucklöffel  
Solid With Rim Lock

07-136-U1

07-137-U2

07-138-U3

07-139-U4

07-140-U5



XL

L

M

S

XS

Upper		A (left-right)	B (top-bottom)
07-136-U1	XL	81 mm	63 mm
07-137-U2	L	73 mm	58 mm
07-138-U3	M	71 mm	52 mm
07-139-U4	S	67 mm	53 mm
07-140-U5	XS	65 mm	51 mm

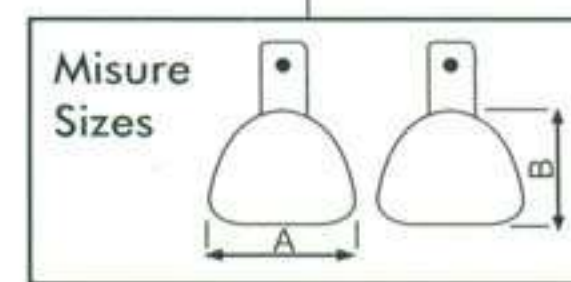

Lower		A (left-right)	B (top-bottom)
07-141-L1	XL	78 mm	63 mm
07-142-L2	L	74 mm	62 mm
07-143-L3	M	72 mm	59 mm
07-144-L4	S	70 mm	57 mm
07-145-L5	XS	69 mm	55 mm

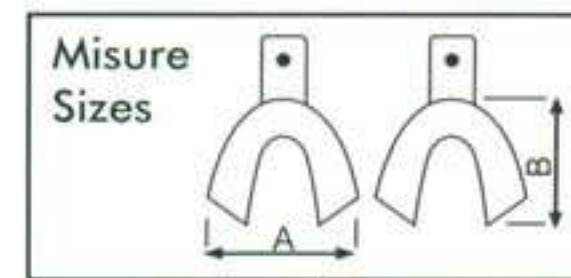

XL

L

M

S

XS

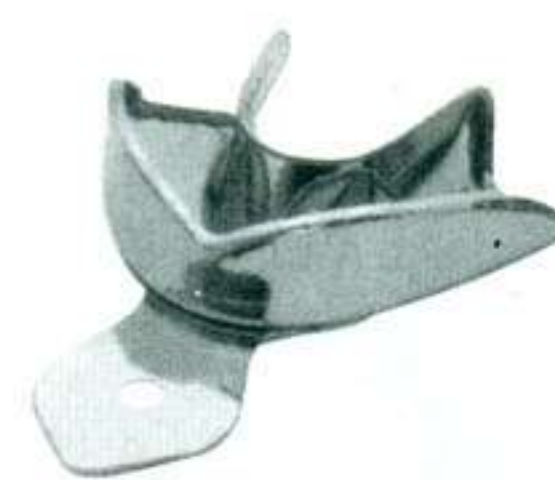

07-141-L1

07-142-L2

07-143-L3

07-144-L4

07-145-L5





# IMPRESSION TRAYS

Porte-empreinte  
ложки впечатление

Cubetas para impresiones  
Відбиткові ложки

Abdrucklöffel

Perforated Without Rim Lock

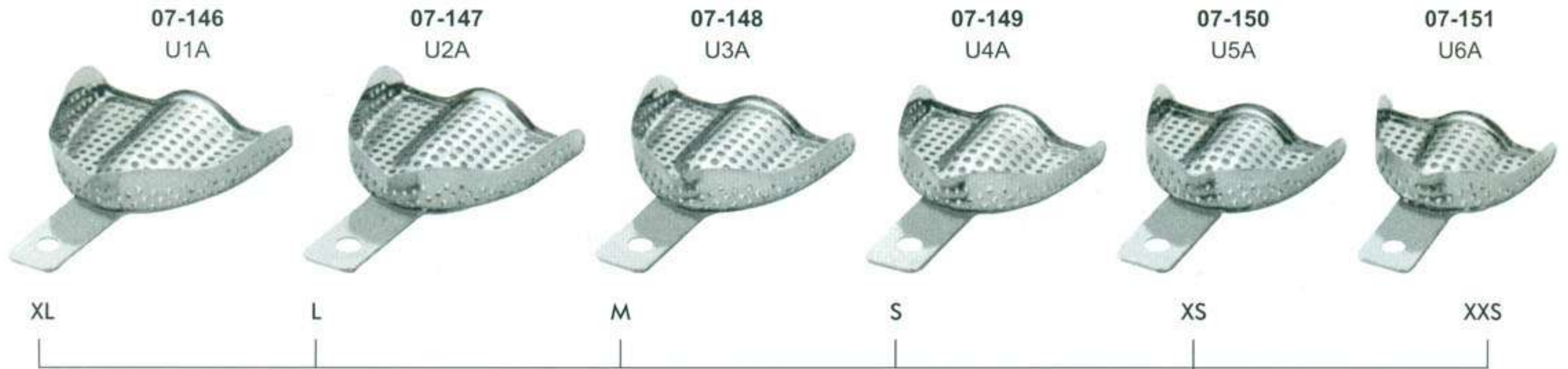

Upper		A (left-right)	B (top-bottom)
07-146-U1	XL	81 mm	63 mm
07-147-U2	L	73 mm	58 mm
07-148-U3	M	71 mm	52 mm
07-149-U4	S	67 mm	53 mm
07-150-U5	XS	65 mm	51 mm
07-151-U6	XXS	61 mm	50 mm

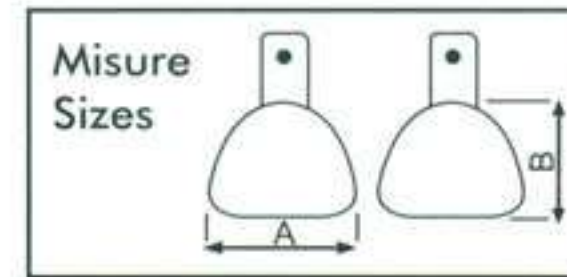

Lower		A (left-right)	B (top-bottom)
07-152-L1	XL	78 mm	63 mm
07-153-L2	L	74 mm	62 mm
07-154-L3	M	72 mm	59 mm
07-155-L4	S	70 mm	57 mm
07-156-L5	XS	69 mm	55 mm
07-157-L6	XXS	59 mm	50 mm

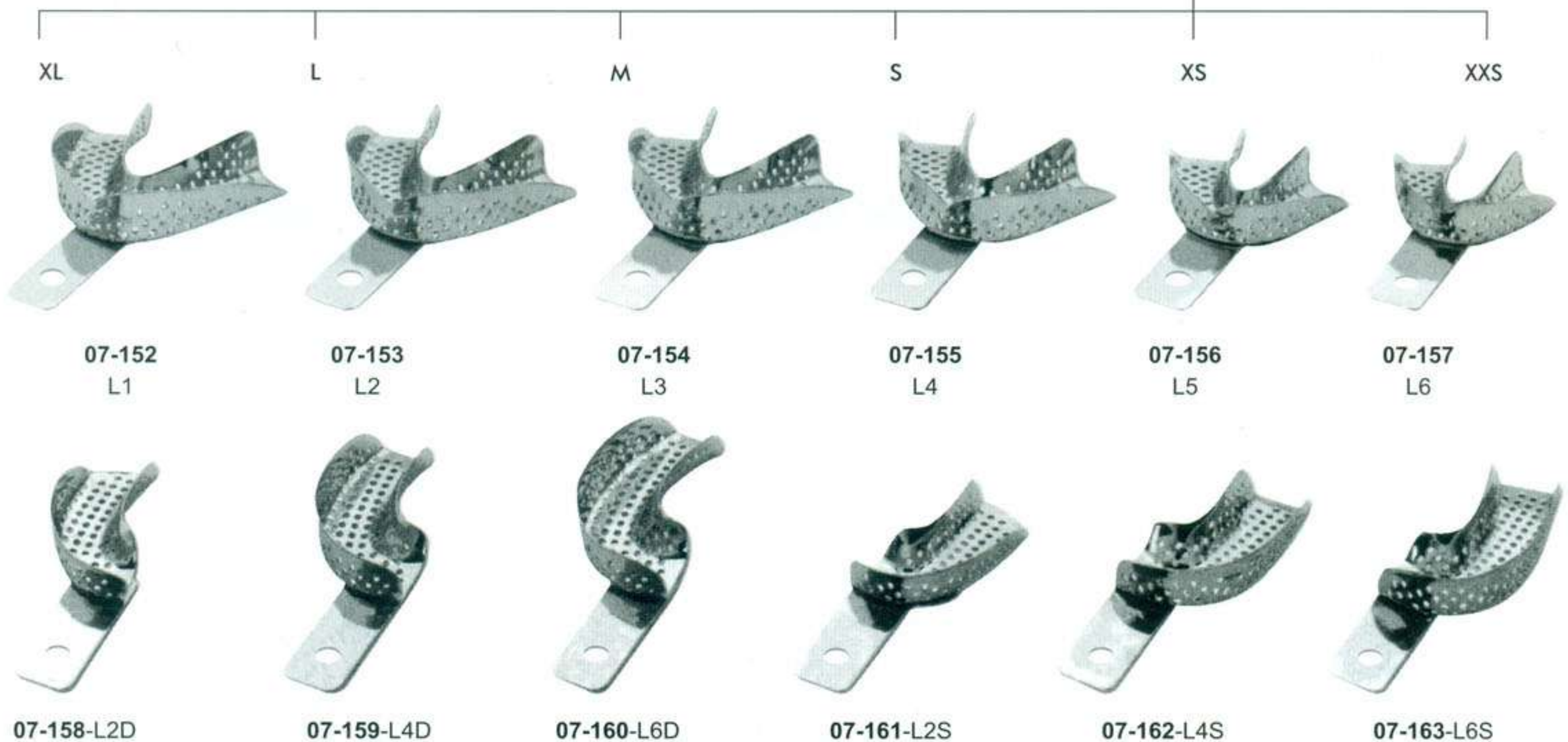
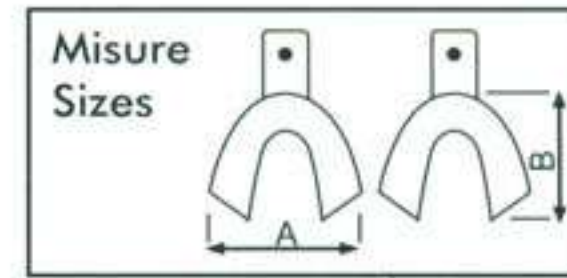





# IMPRESSION TRAYS

Porte-empreinte  
ложки впечатление

Cubetas para impresiones  
Відбиткові ложки

Abdrucklöffel

Ehricke Stainless Steel  
Perforated Without Rim Lock

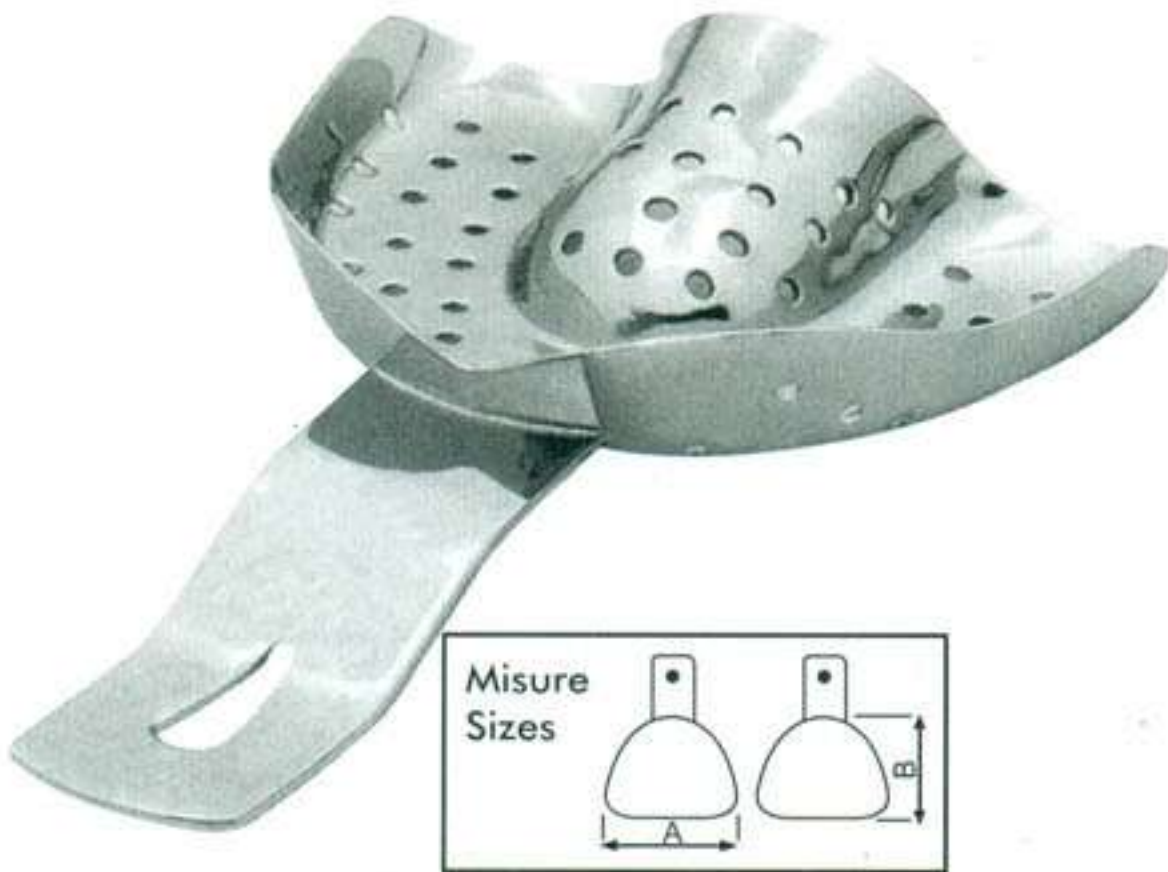

For Toothed Upper Jaws  
(Fig. 0 for children)

	A mm.	B mm.
<b>07-164-OB 0</b>	59	52
<b>07-165-OB 1</b>	66	52
<b>07-166-OB 2</b>	71	62
<b>07-167-OB 3</b>	71	64
<b>07-168-OB 4</b>	80	70

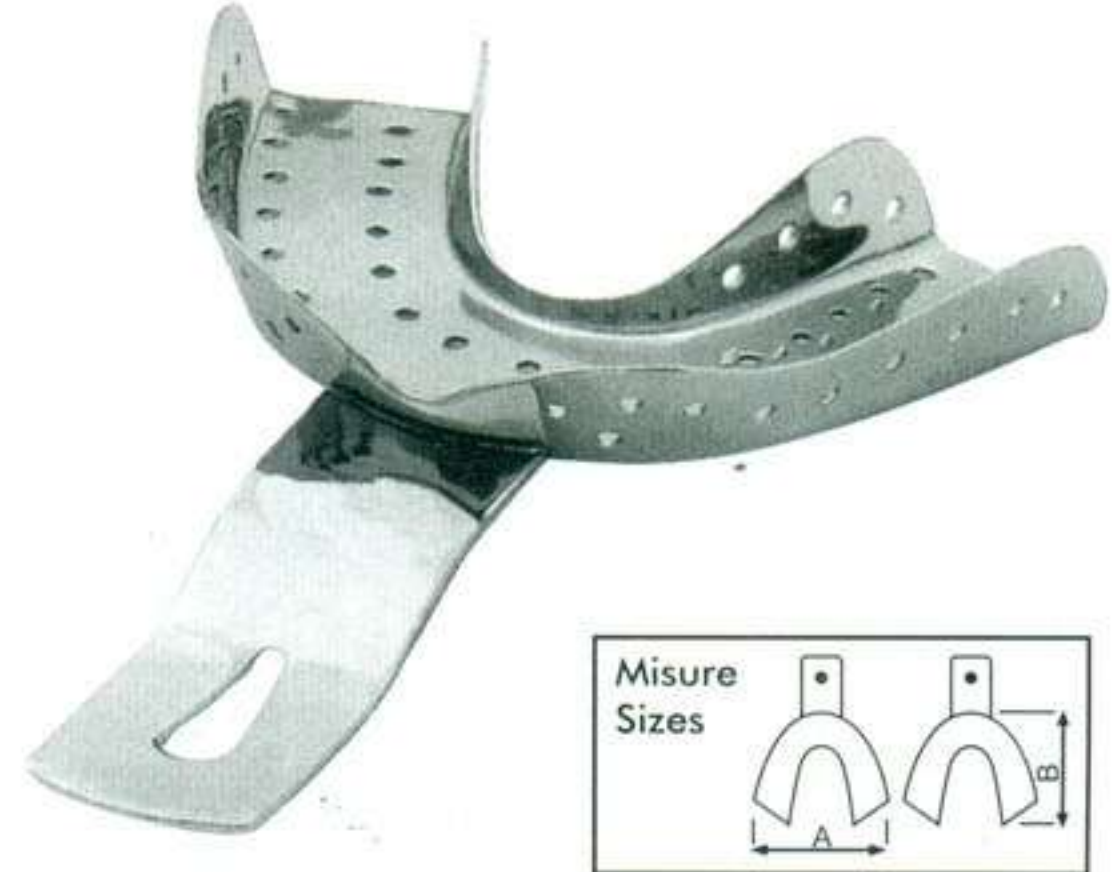

For Toothed Lower Jaws  
(Fig. 0 for children)

	A mm.	B mm.
<b>07-169-UB 0</b>	65	46
<b>07-170-UB 1</b>	67	50
<b>07-171-UB 2</b>	76	54
<b>07-172-UB 3</b>	79	56
<b>07-173-UB 4</b>	79	61



For Narrow Toothed Upper Jaws

	A mm.	B mm.
<b>07-174-BS 2</b>	70	54



Porte-empreinte  
ложки впечатление

Cubetas para impresiones  
Відбиткові ложки

**Abdrucklöffel**  
Ehricke Stainless Steel  
Perforated Without Rim Lock

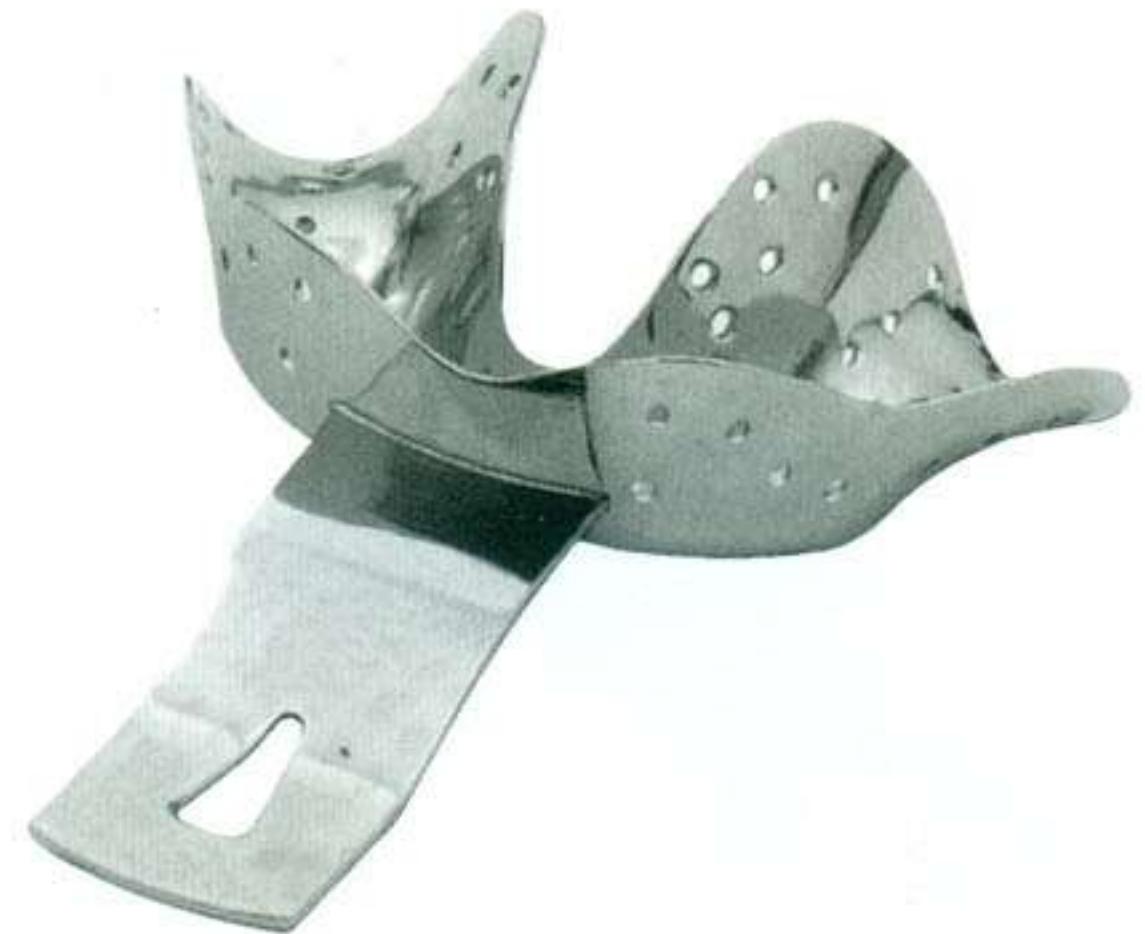

For partially toothed upper jaws

For partially toothed lower jaws

	A mm.	B mm.
<b>07-175-OP 1</b>	62	50
<b>07-176-OP 2</b>	70	56

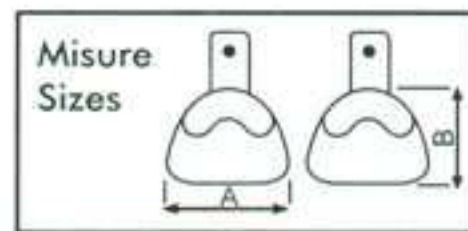

	A mm.	B mm.
<b>07-177-UP 1</b>	70	55
<b>07-178-UP 2</b>	78	59

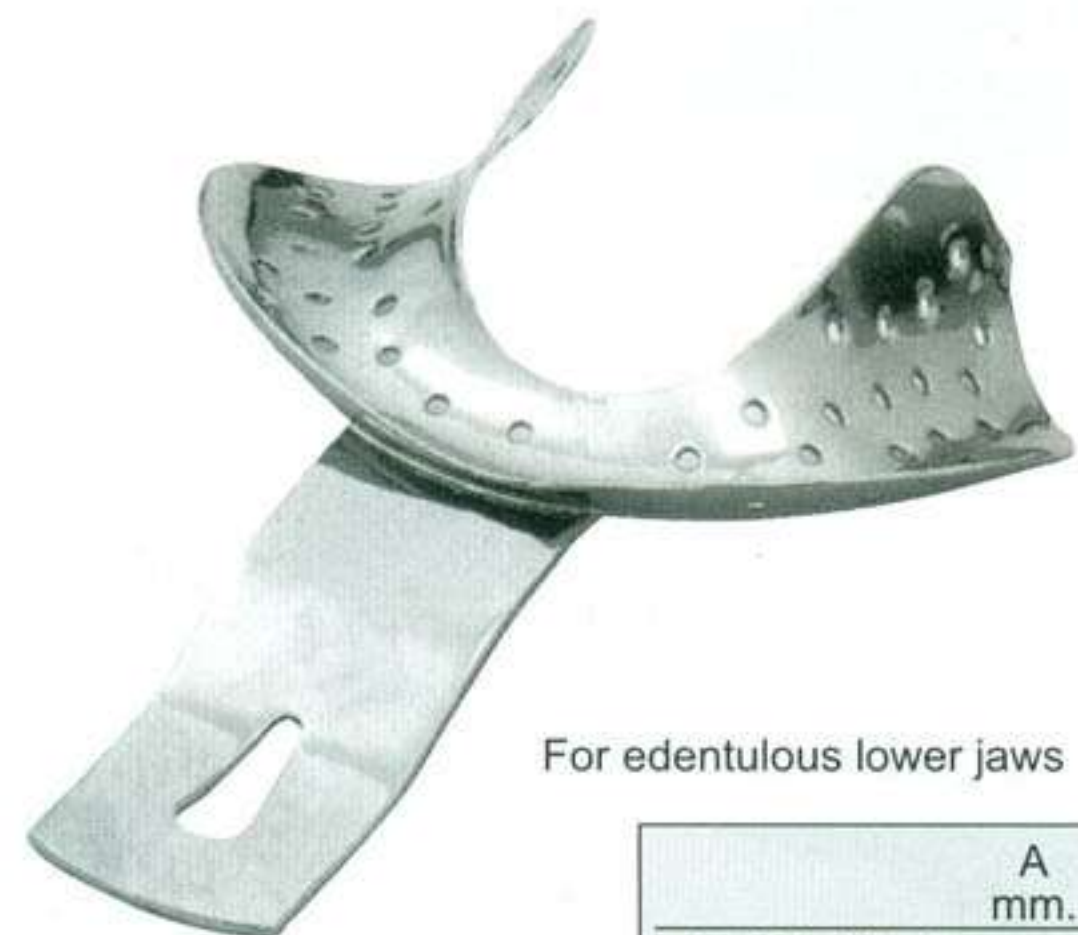
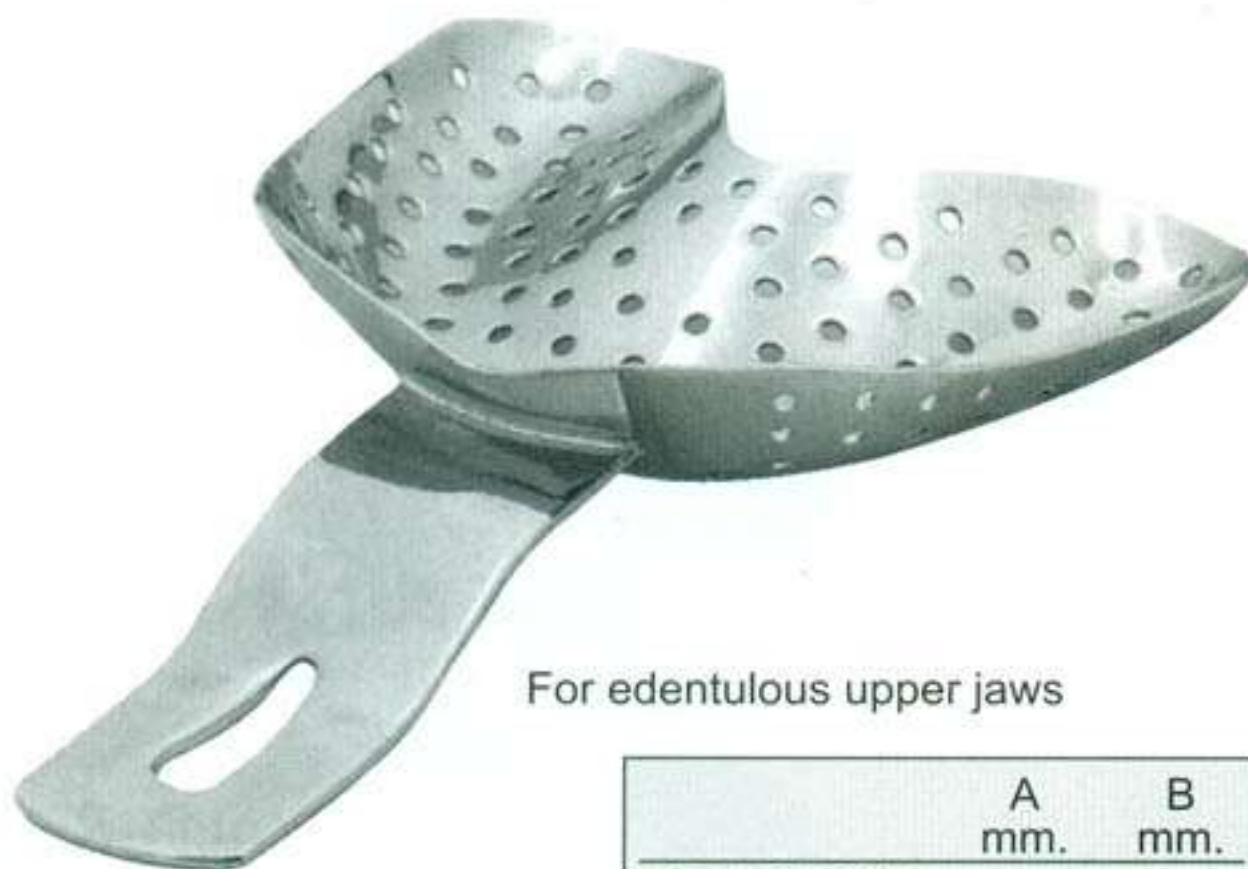
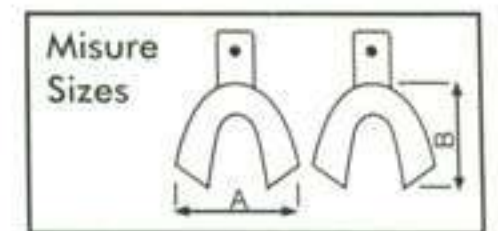

For edentulous upper jaws

For edentulous lower jaws

	A mm.	B mm.
<b>07-179-OU 1</b>	64	46
<b>07-180-OU 2</b>	68	53
<b>07-181-OU 3</b>	79	61

	A mm.	B mm.
<b>07-182-UU 1</b>	70	48
<b>07-183-UU 2</b>	70	53
<b>07-184-UU 3</b>	72	57





# IMPRESSION TRAYS

Porte-empreinte  
ложки впечатление

Cubetas para impresiones  
Відбиткові ложки

Abdrucklöffel

Perforated With Rim Lock



Solid stainless steel anterior depressed impression trays with retention rim.

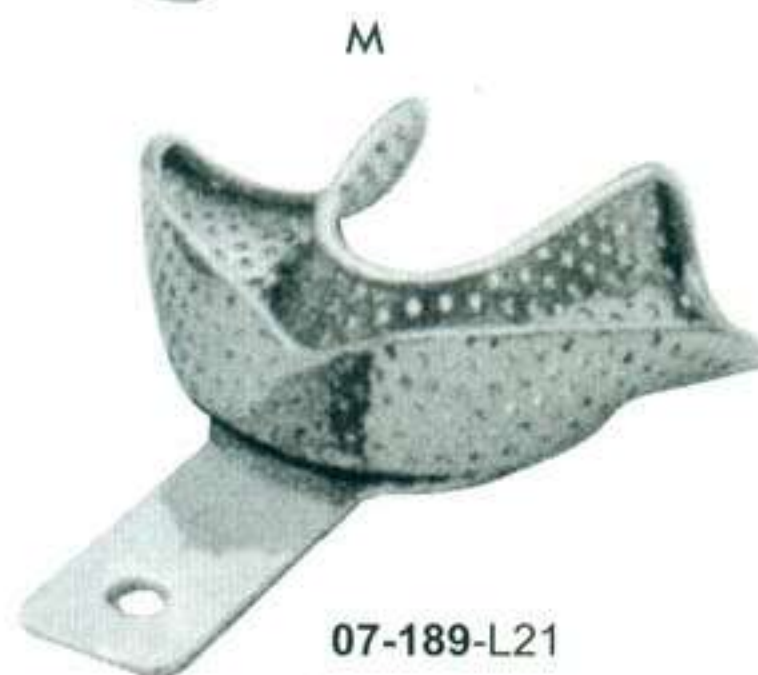
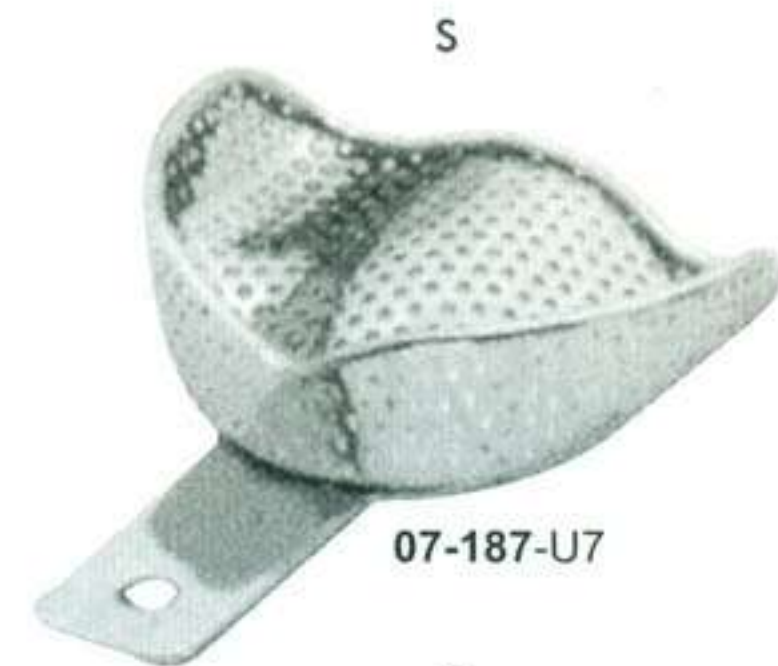
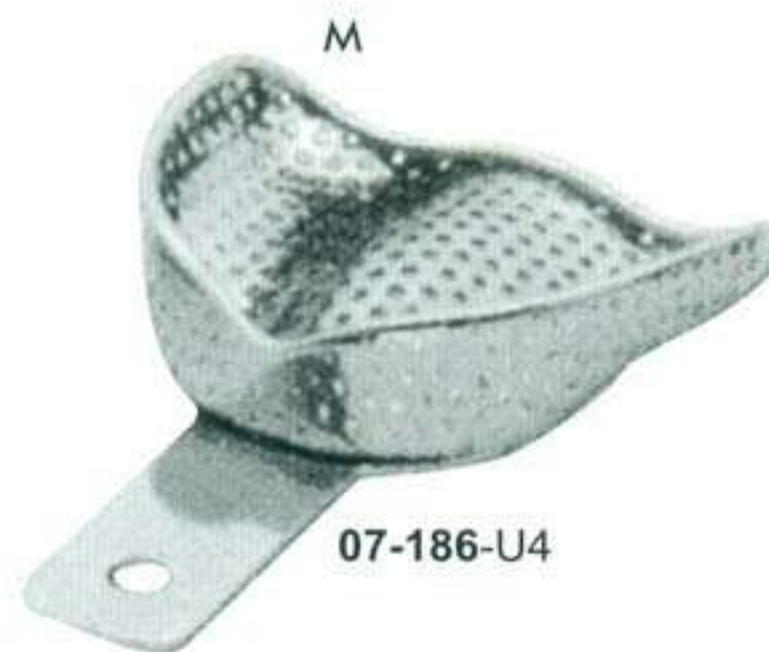
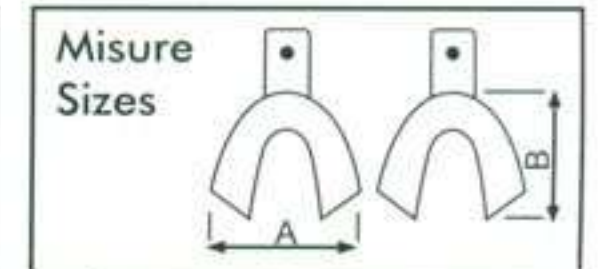
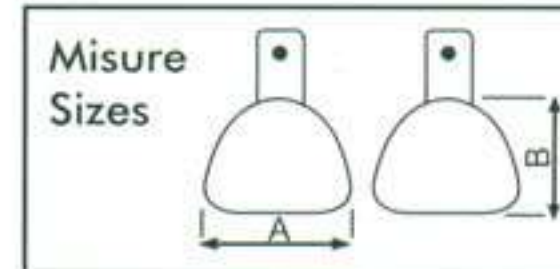

		A mm.	B mm.
07-185-U1	L	81	67
07-186-U4	M	71	64
07-187-U7	S	70	57

		A mm.	B mm.
07-188-L20	L	81	60
07-189-L21	M	79	57
07-190-L22	S	76	54





# IMPRESSION TRAYS

Porte-empreinte  
ложки впечатление

Cubetas para impresiones  
Відбиткові ложки

Abdrucklöffel

Perforated Full Denture



Solid total denture stainless steel impression trays with rim.

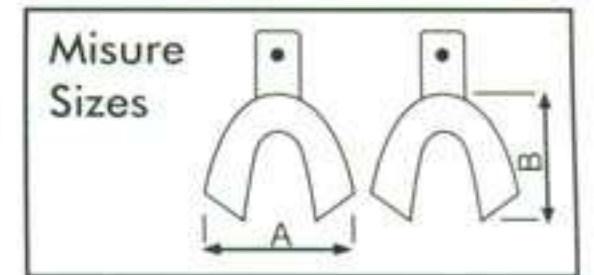
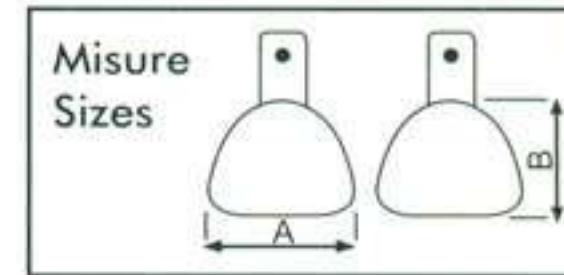

07-191-U61



07-192-U62

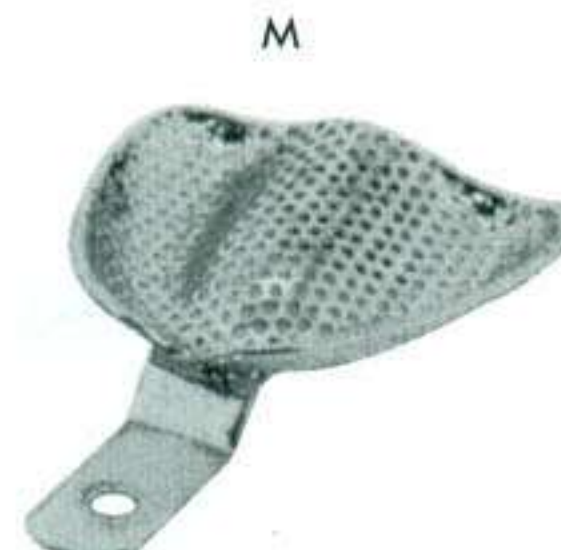

07-193-U63

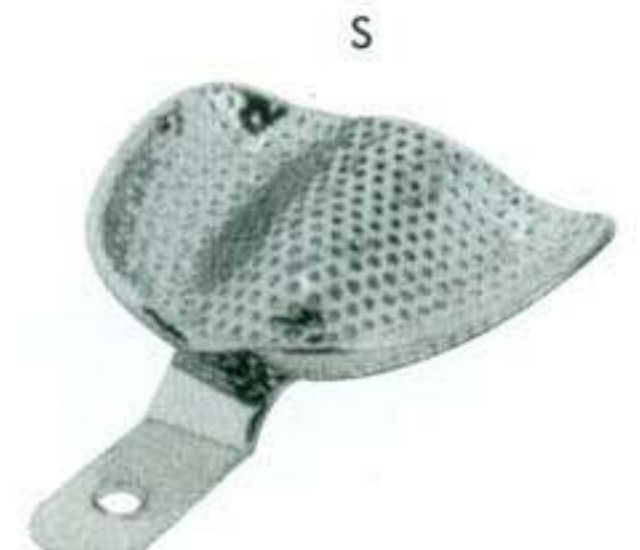

07-194-U64



07-195-L66



07-196-L67

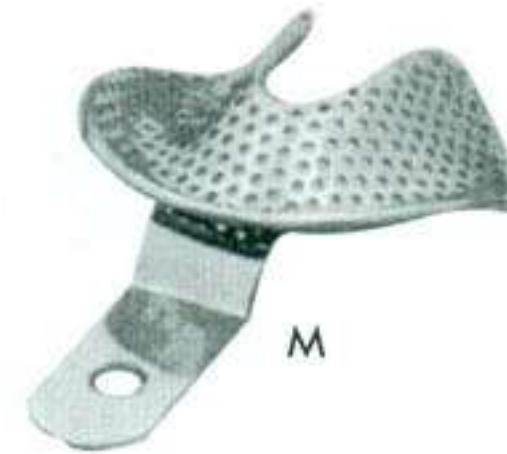

07-197-L68



07-198-L69

		A mm.	B mm.
07-191-U61	XL	79	70
07-192-U62	L	76	67
07-193-U63	M	70	64
07-194-U64	S	73	60

		A mm.	B mm.
07-195-L66	XL	86	64
07-196-L67	L	70	64
07-197-L68	M	73	60
07-198-L69	S	70	57





# IMPRESSION TRAYS

Porte-empreinte  
ложки впечатление

Cubetas para impresiones  
Відбиткові ложки

Abdrucklöffel

Solid With Rim Lock



Solid stainless steel anterior depressed impression trays with retention rim.

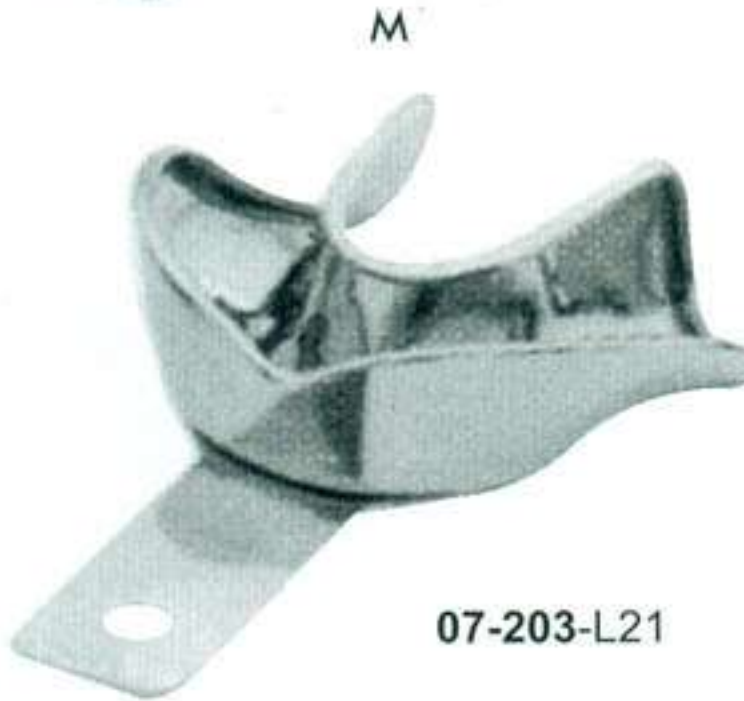
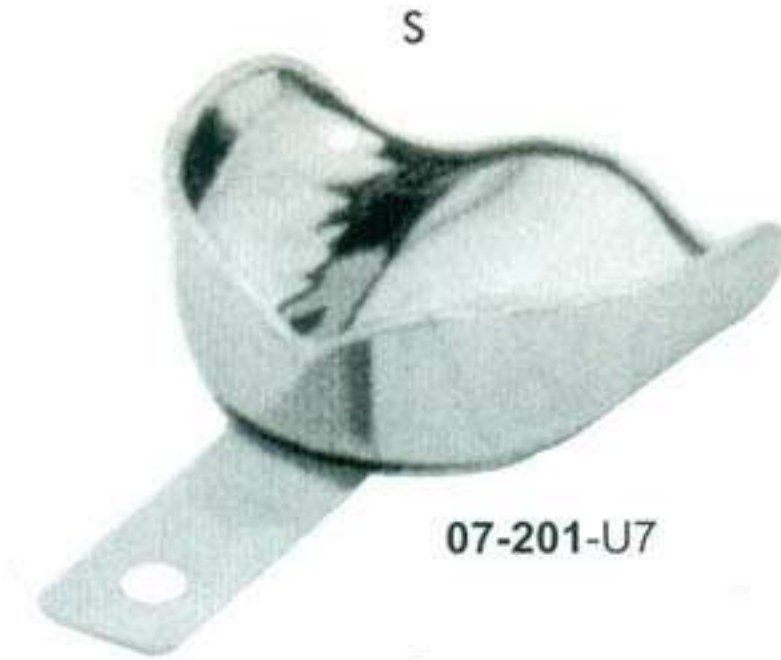
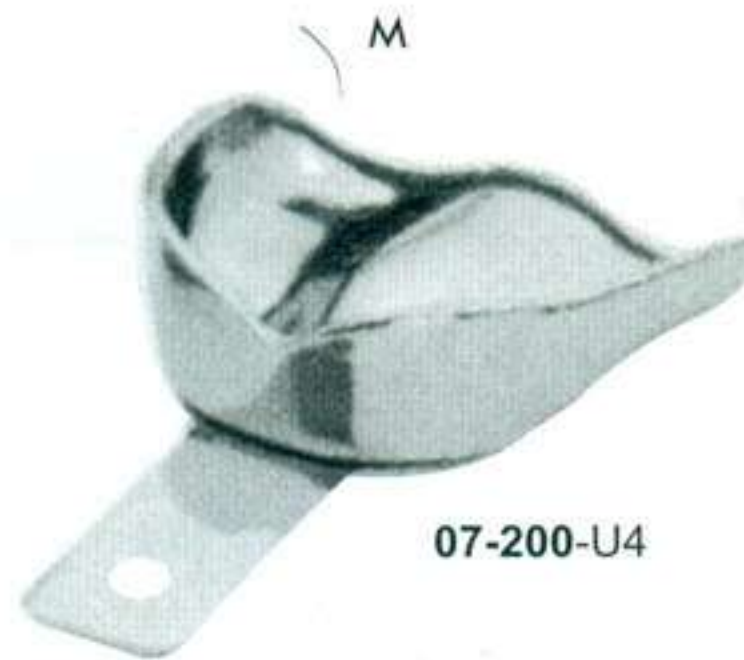
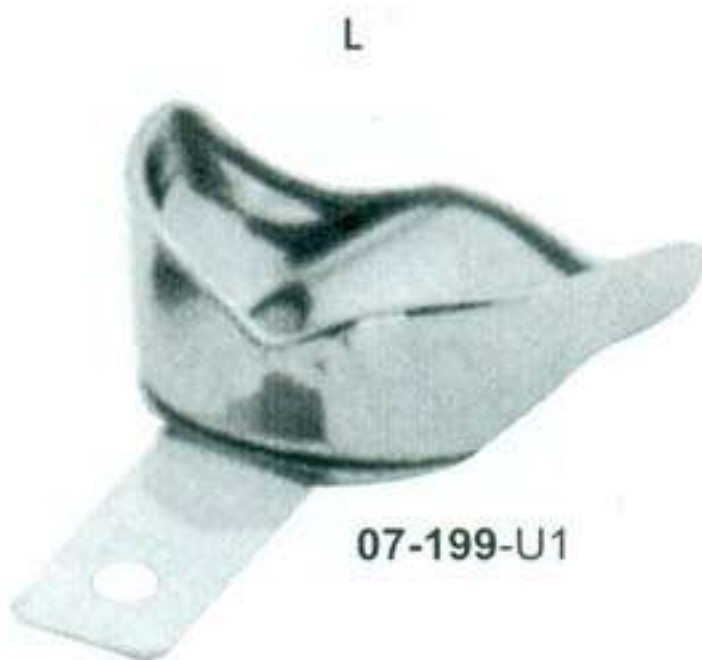
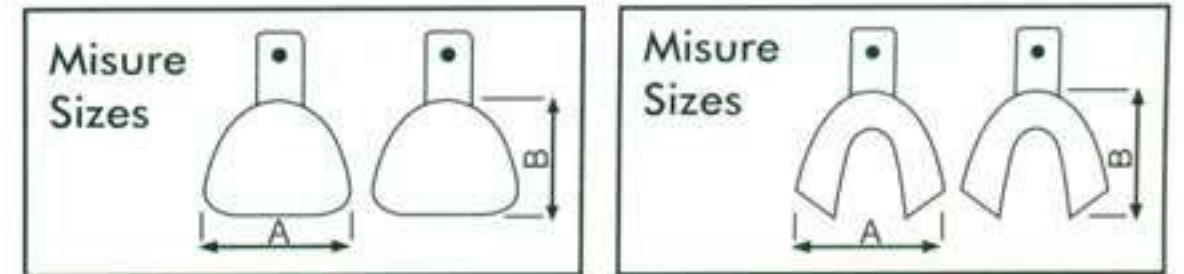

		A mm.	B mm.
07-199-U1	L	81	67
07-200-U4	M	71	64
07-201-U7	S	70	57

		A mm.	B mm.
07-202-L20	L	81	60
07-203-L21	M	79	57
07-204-L22	S	76	54





# IMPRESSION TRAYS

Porte-empreinte  
ложки впечатление

Cubetas para impresiones  
Відбиткові ложки

Abdrucklöffel  
Solid Full Denture



Solid total denture stainless steel impression trays with rim.

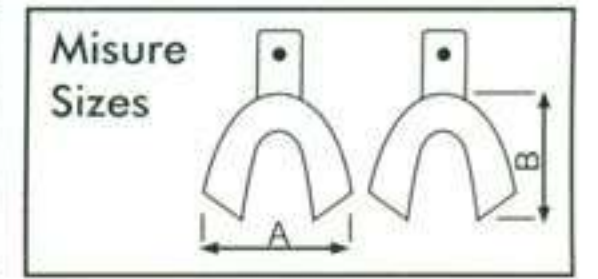
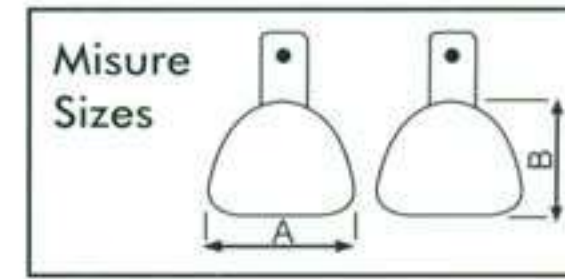

07-205-U61

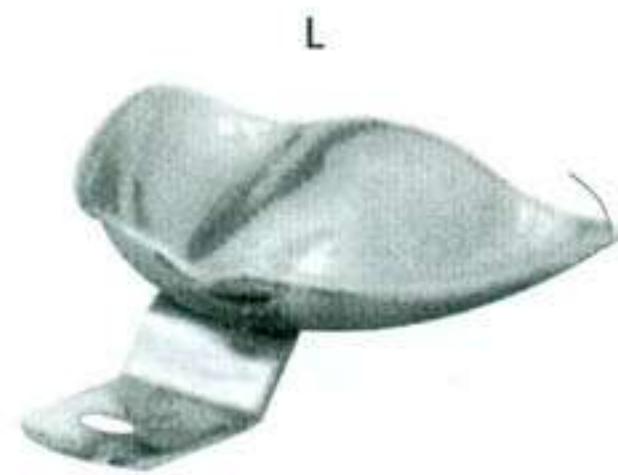

07-206-U62

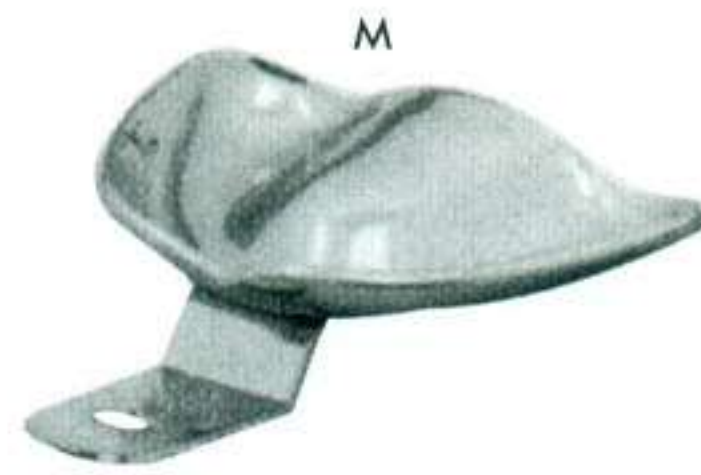

07-207-U63

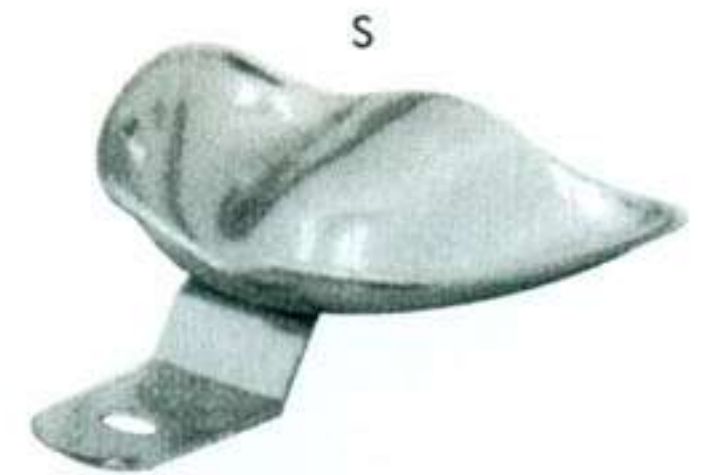

07-207-U64



07-209-L66



07-210-L67

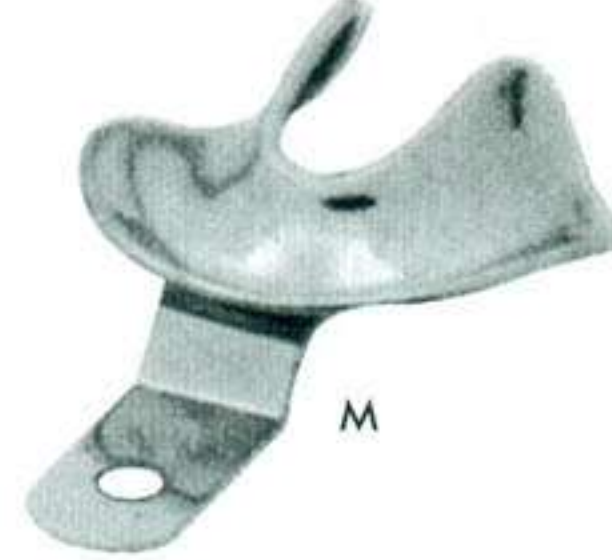

07-211-L68



07-212-L69

		A mm.	B mm.
07-205-U61	XL	79	70
07-206-U62	L	76	67
07-207-U63	M	70	64
07-207-U64	S	73	60

		A mm.	B mm.
07-209-L66	XL	86	64
07-210-L67	L	70	64
07-211-L68	M	73	60
07-212-L69	S	70	57





# IMPRESSION TRAYS

Porte-empreinte  
ложки впечатление

Cubetas para impresiones  
Відбиткові ложки

Abdrucklöffel  
Solid Without Rim Lock

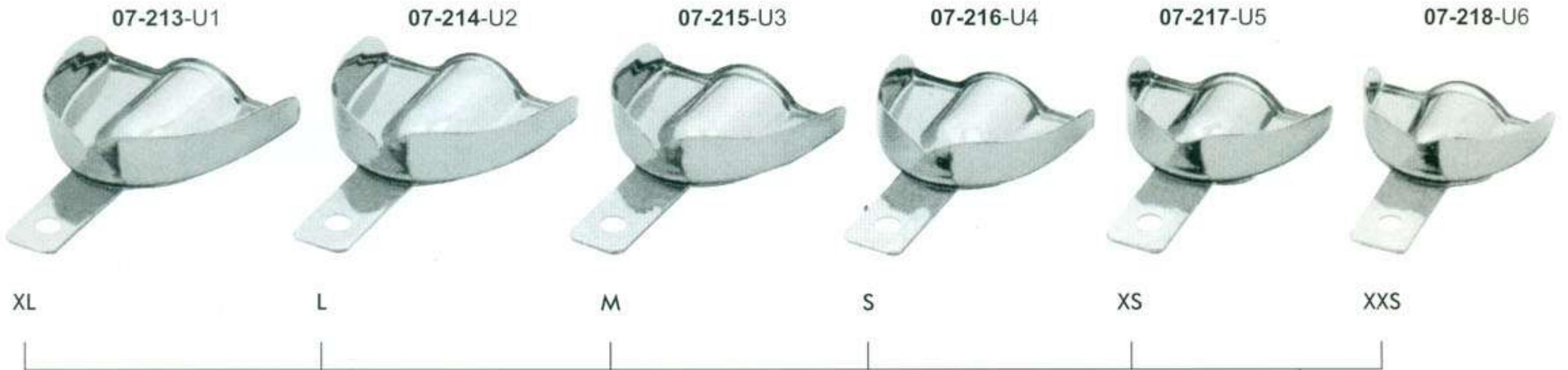

Upper		A (left-right)	B (top-bottom)
07-213-U1	XL	81 mm	63 mm
07-214-U2	L	73 mm	58 mm
07-215-U3	M	71 mm	52 mm
07-216-U4	S	67 mm	53 mm
07-217-U5	XS	65 mm	51 mm
07-218-U6	XXS	61 mm	50 mm

Lower		A (left-right)	B (top-bottom)
07-219-L1	XL	78 mm	63 mm
07-220-L2	L	74 mm	62 mm
07-221-L3	M	72 mm	59 mm
07-222-L4	S	70 mm	57 mm
07-223-L5	XS	69 mm	55 mm
07-224-L6	XXS	59 mm	50 mm

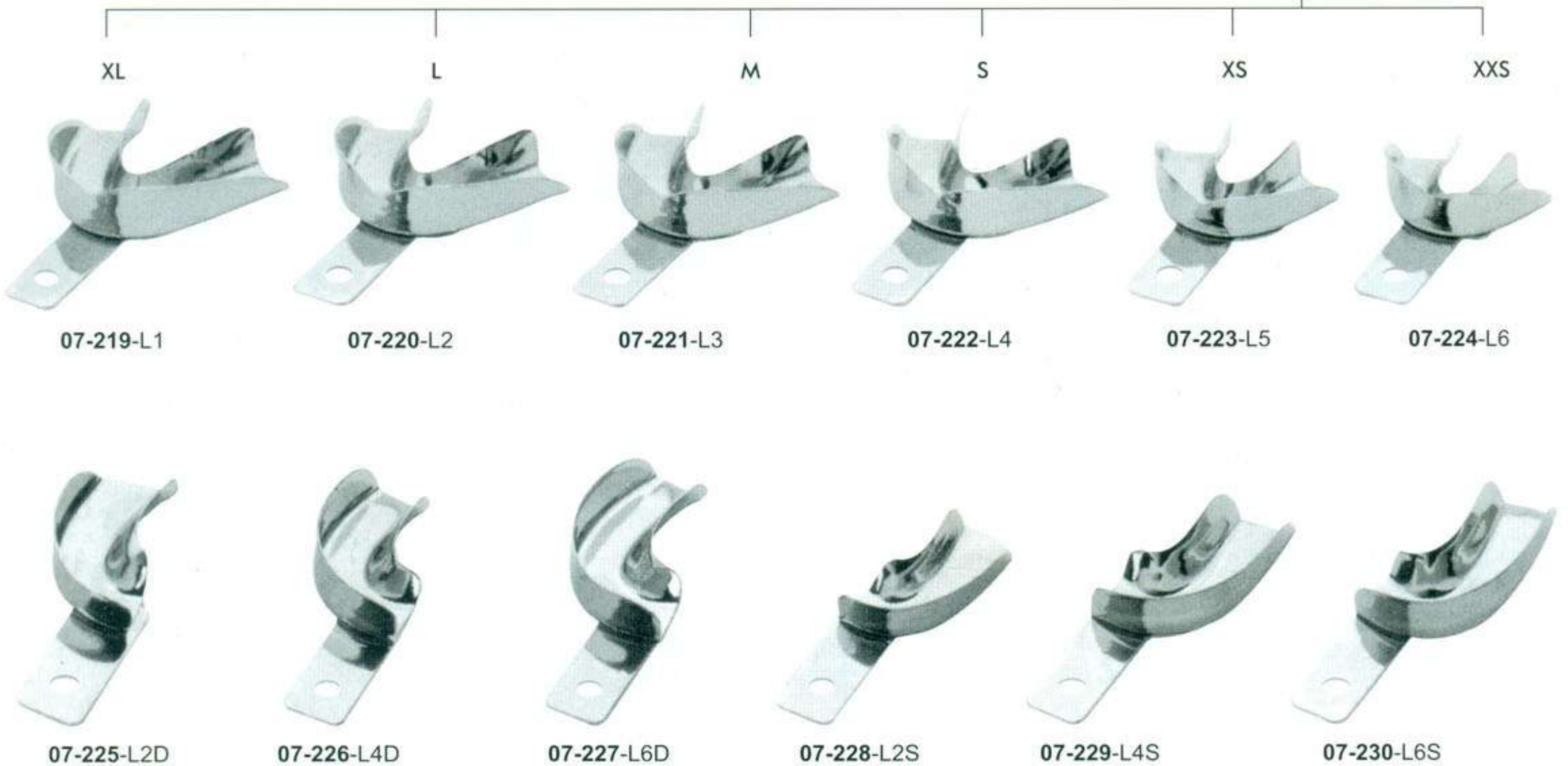
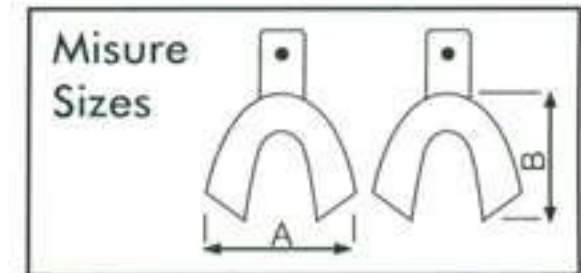
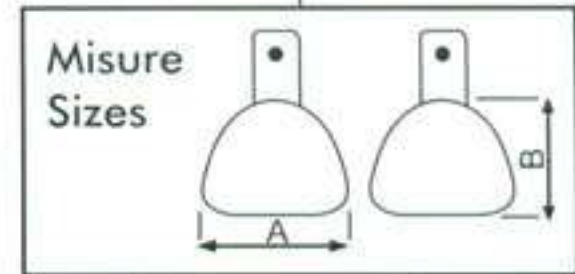





# IMPRESSION TRAYS

Porte-empreinte  
ложки впечатление

Cubetas para impresiones  
Відбиткові ложки

Abdrucklöffel

U18



U17



U16



U15



**07-231**  
Impression Trays  
Set of 8 Pieces  
Perforated Stainless  
steel Coe Type



L18



L17



L16



L15

U24



U23



U22



U21



**07-232**  
Impression Trays  
Set of 8 Pieces  
Plain Stainless Steel  
Rim Lock Type for  
Senior Persons



L24



L23



L22



L21





# IMPRESSION TRAYS

Porte-empreinte  
ложки впечатление

Cubetas para impresiones  
Відбиткові ложки

Abdrucklöffel

U24

U23

U22

U21



07-233

Impression Trays  
Set of 8 Pieces  
Perforated Stainless  
steel Coe Type  
for Senior Persons



L24

L23

L22

L21

U4

U3

U2



07-234

Impression Trays  
Set of 6 Pieces  
Plain Stainless steel  
Rim Lock Type



L4

L3

L2





# IMPRESSION TRAYS

Porte-empreinte  
ложки впечатление

Cubetas para impresiones  
Відбиткові ложки

Abdrucklöffel

U4



U3



U2



07-235  
Impression Trays  
Set of 6 Pieces  
Perforated Stainless  
steel CoeType



L4



L3



L2

U15



U16



U17



U18



07-236  
Impression Trays  
Set of 8 Pieces  
Plain Stainless steel  
Rim Lock Type  
for Children



L15



L16

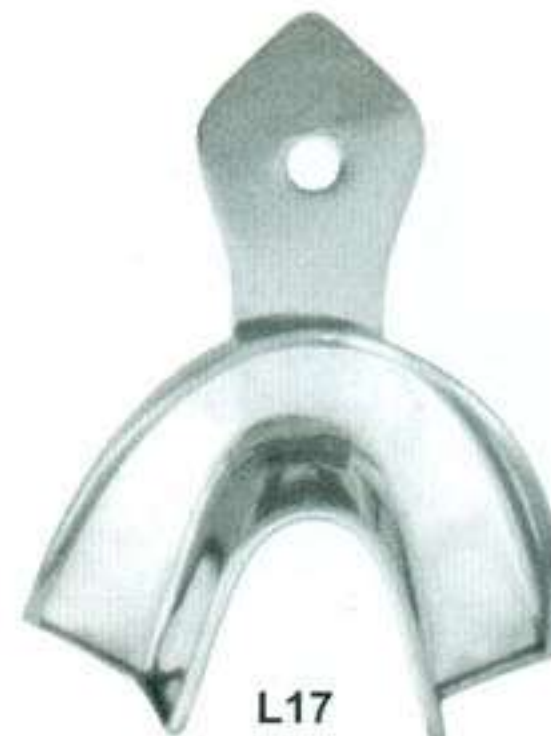

L17



L18





# STERILE WASH TRAY SYSTEM

Контейнеры системы Steri-Wash

Контейнеры системы Steri-Wash

## Steri Wash Tray System

Easy To use  
Fully Hygienic  
Time Saving  
Longer Instrument Lift  
Modern & Practical Design

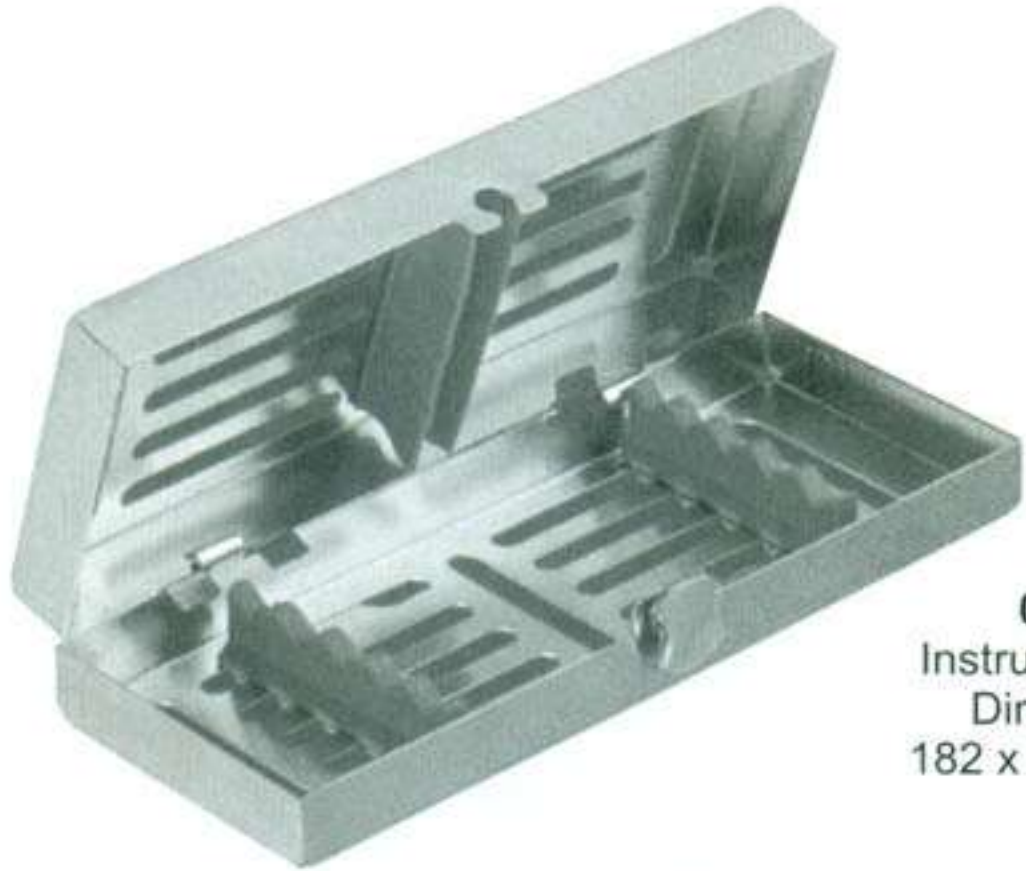

**07-244**  
Instruments Tray  
Dimensions  
182 x 72 x 34 mm



**07-246**  
Instruments Tray  
Dimensions  
182 x 144 x 34 mm



**07-245**  
Instruments Tray  
Dimensions  
288 x 182 x 34 mm

Locking System

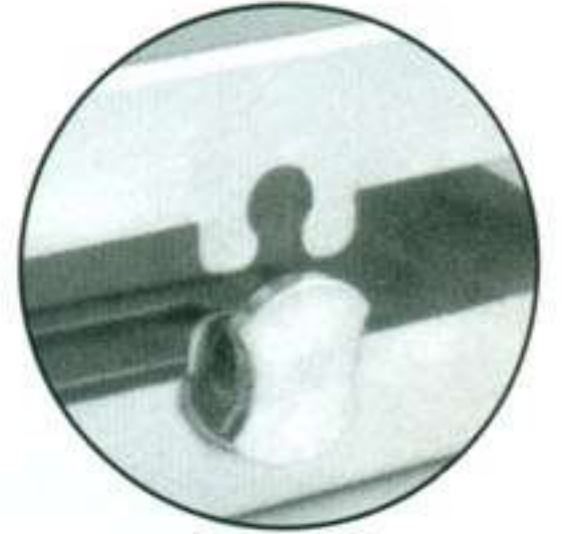

### ECONOMY STERI WASH TRAY SYSTEM

Instrument Tray Complete with  
Base, Lid, Silicon Insert Frame & Holder

Locking System

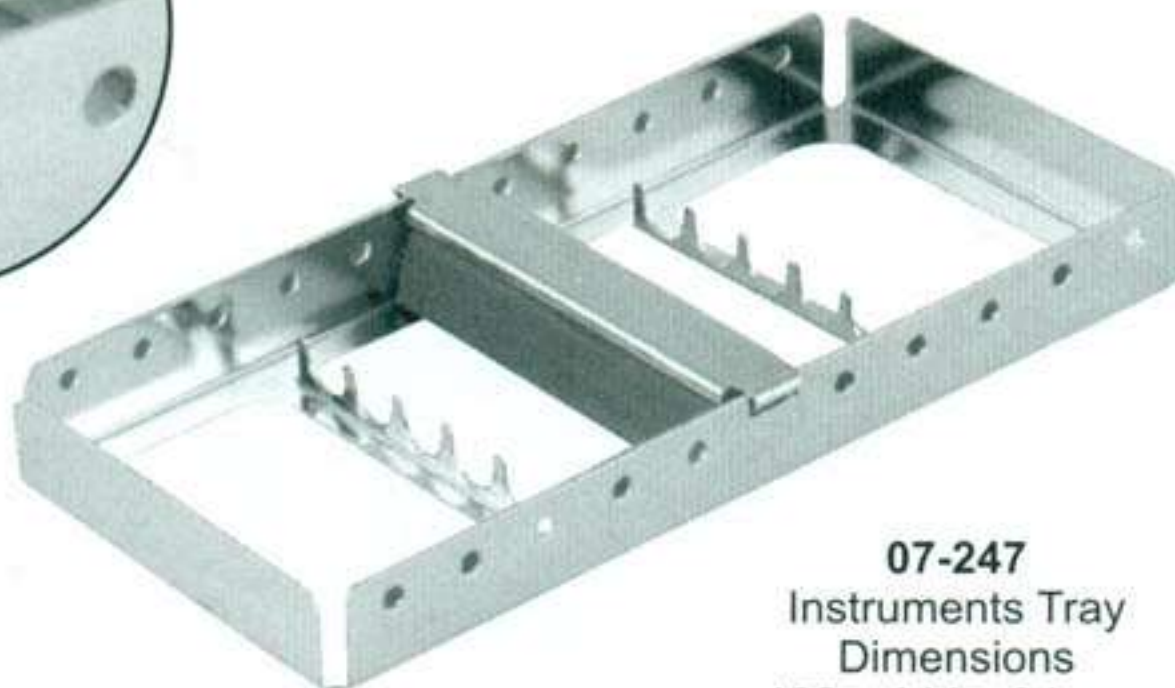
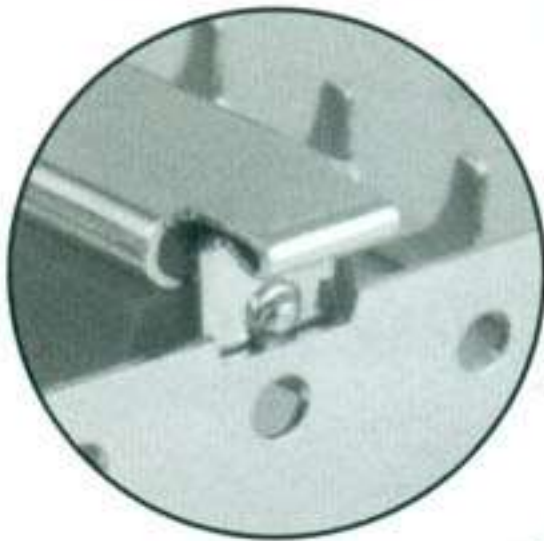

**07-247**  
Instruments Tray  
Dimensions  
182 x 144 x 34 mm

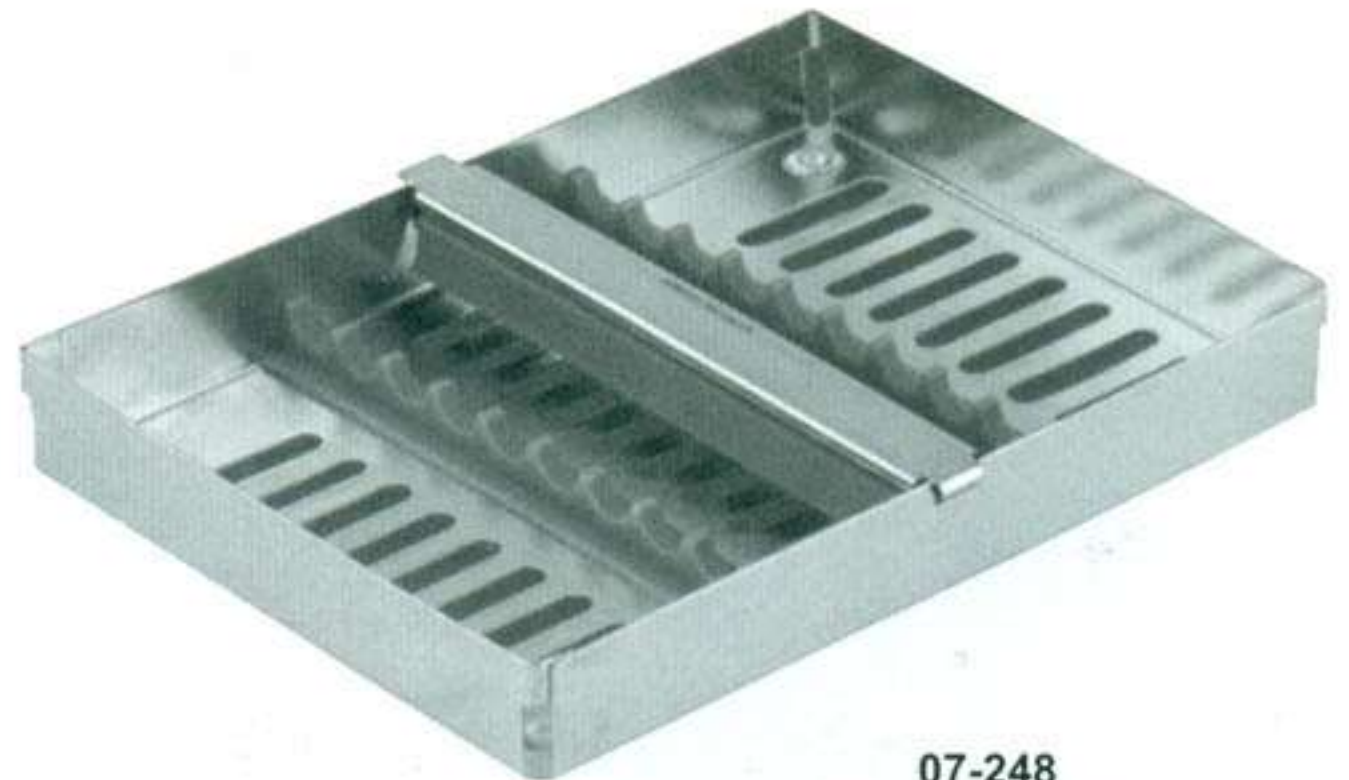

**07-248**  
Instruments Tray  
Dimensions  
182 x 144 x 34 mm





# STERILE WASH TRAY SYSTEM

Контейнеры системы Steri-Wash

Контейнеры системы Steri-Wash

## Steri Wash Tray System

Locking System



**07-249**  
Instruments Tray  
Dimensions  
185 x 65 x 22 mm



**07-250**  
Instruments Tray  
Dimensions  
185 x 130 x 22 mm



**07-251**  
Instruments Tray  
Dimensions  
280 x 180 x 25 mm



## MESH TRAYS

Different sizes & dimensions  
are available at buyer's  
demand



**Sizes:**  
**07-252** 240x130x50mm  
**07-253** 240x130x60mm  
**07-254** 240x250x50mm  
**07-255** 240x250x60mm  
**07-256** 480x250x50mm  
**07-257** 480x250x60mm  
**07-258** 480x250x70mm



**SIZES:**  
**07-259** 240x250x50mm  
**07-260** 240x250x60mm  
**07-261** 240x250x70mm  
**07-262** 480x250x50mm  
**07-263** 480x250x60mm  
**07-264** 480x250x70mm  
**07-265** 480x250x100mm



**Sizes:**  
**07-266** 240x250x50mm  
**07-267** 240x250x60mm  
**07-268** 240x250x70mm  
**07-269** 280x250x50mm  
**07-270** 280x250x60mm



**Sizes:**  
**07-271** 280x250x70mm  
**07-272** 280x250x100mm  
**07-273** 280x250x50mm  
**07-274** 280x280x60mm  
**07-275** 280x280x70mm  
**07-276** 300x280x60mm





# STANDARD TRAY OF STAINLESS STEEL

Контейнер из нержавеющей стали

Контейнер з нержавіючої сталі

## Norm-Tray aus rostfreiem edelstahl

Made of 18/8 stainless steel

**07-309**

Complete instrument tray with perforated base, lid & insert frame for 16 instruments

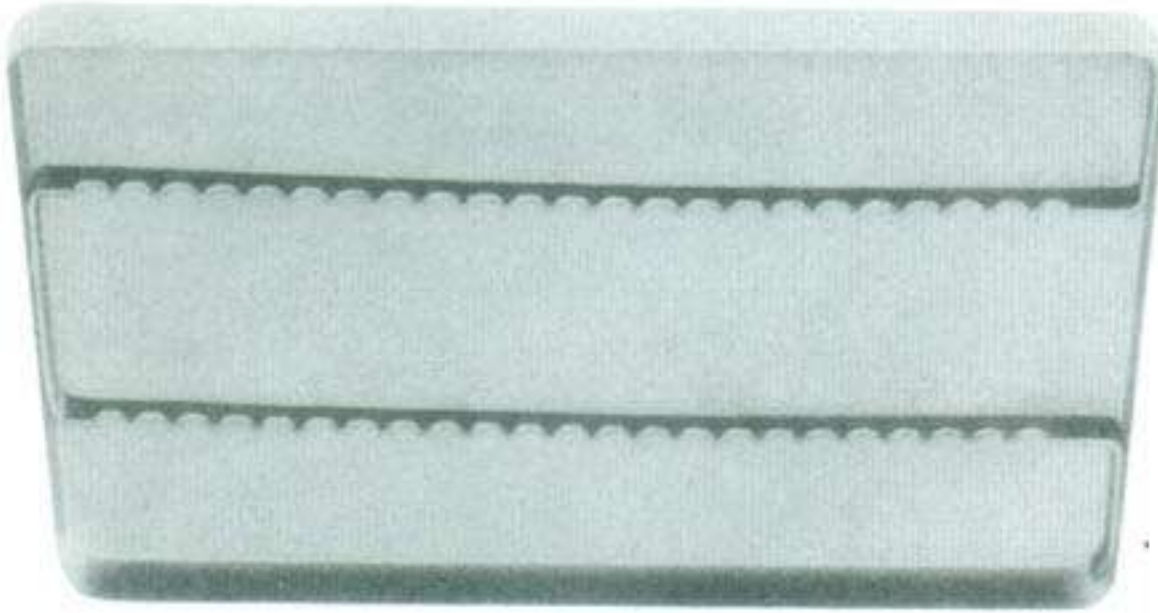

**07-311**

Lid Dimensions mm. 228-187-29



**07-313**

Professional Base: Dimension 284-183-17

**07-315**

Complete instruments tray with solid base, lid & insert frame for 16 instruments

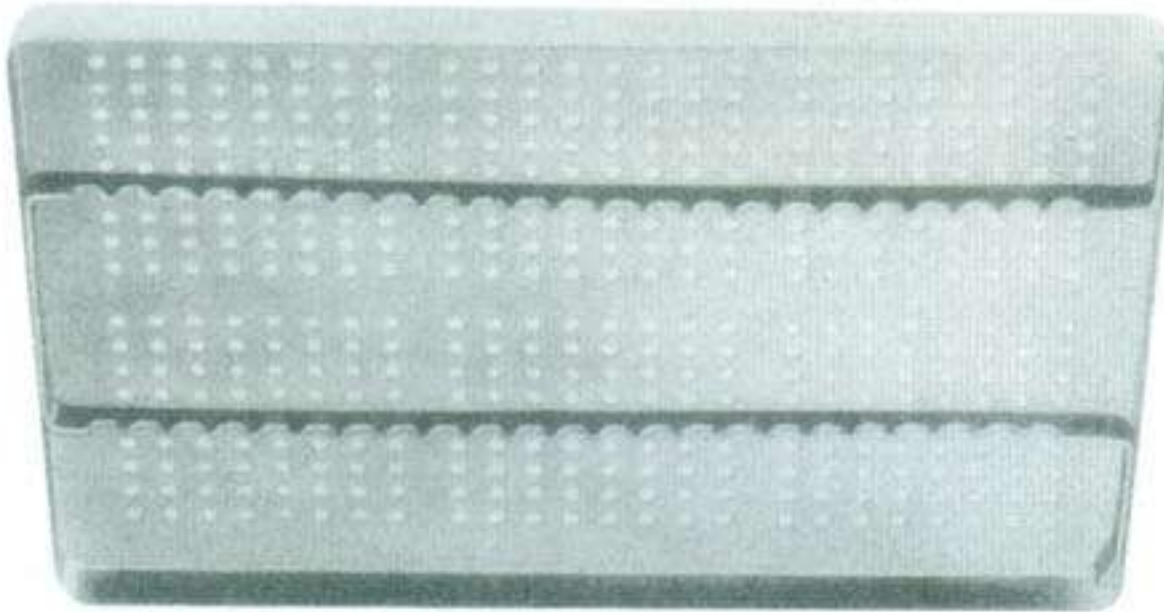

**07-317**

Lid Dimensions 288-187-29mm



**07-319**

Solid Base: Dimensions 284-183-17mm

**07-310**

Complete instrument tray with perforated base, lid & insert frame for 23 instruments

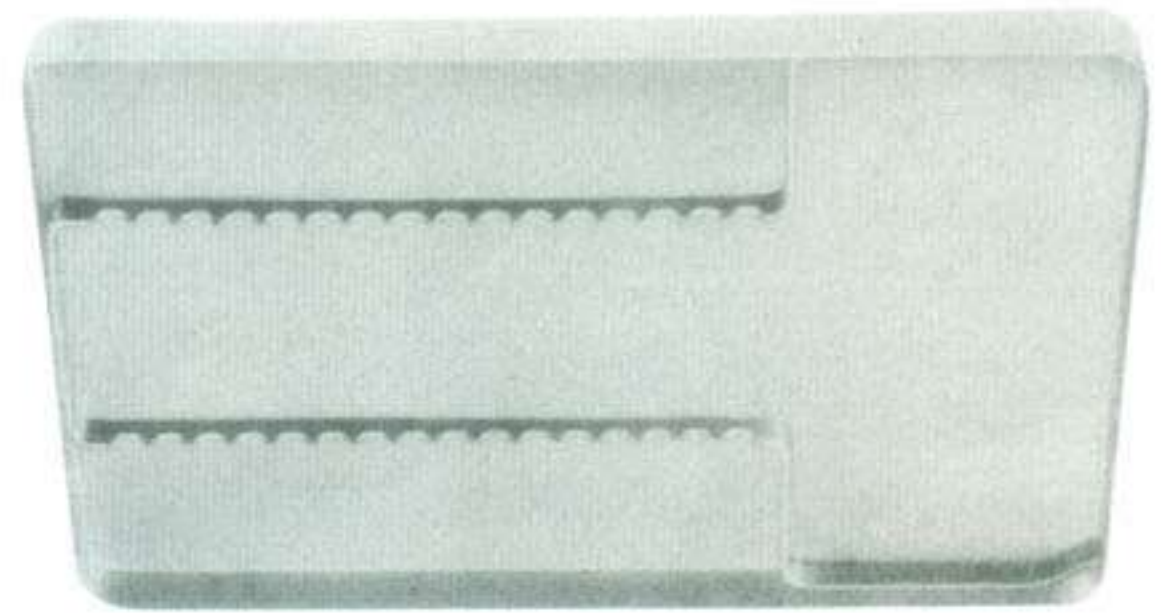

**07-312**

Lid Dimensions mm. 288-187-29

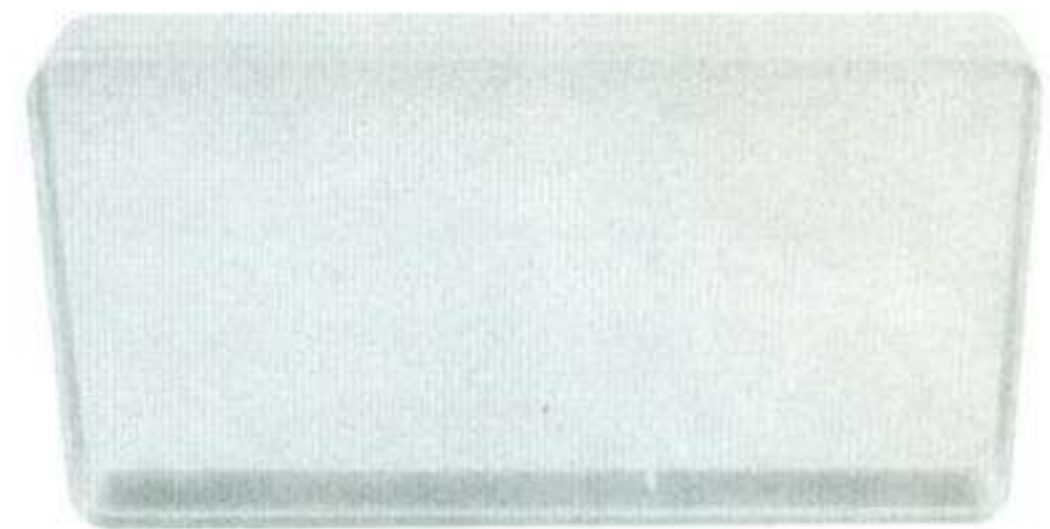

**07-314**

Professional Base: Dimension 284-183-17

**07-316**

Complete instruments tray with solid base, lid & insert frame for 23 instruments

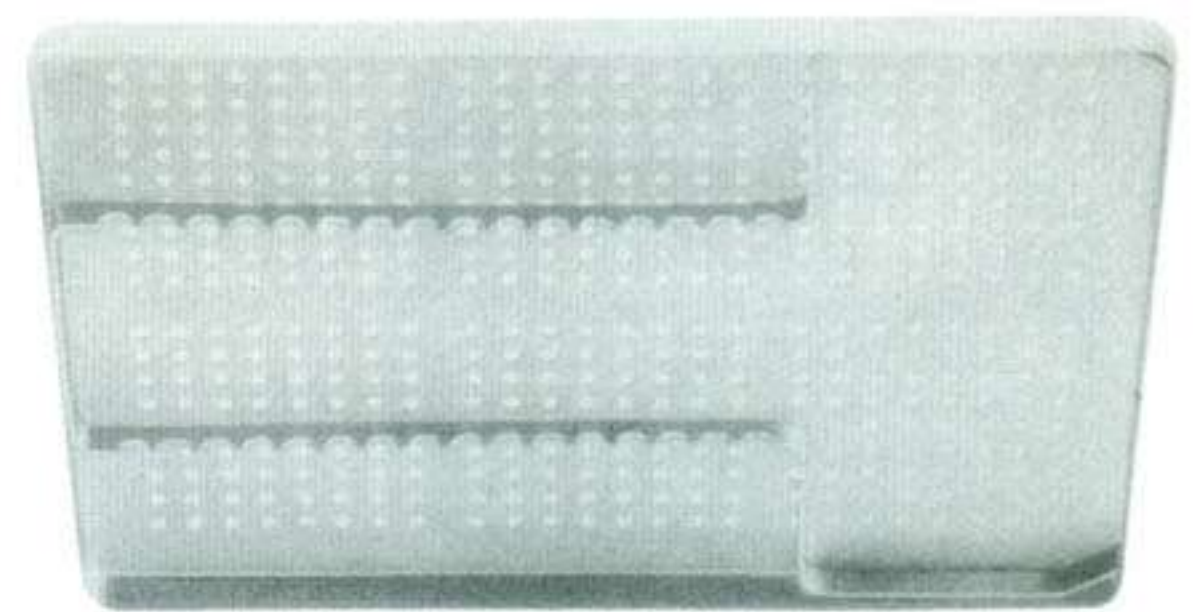

**07-318**

Lid Dimensions 288-187-29mm

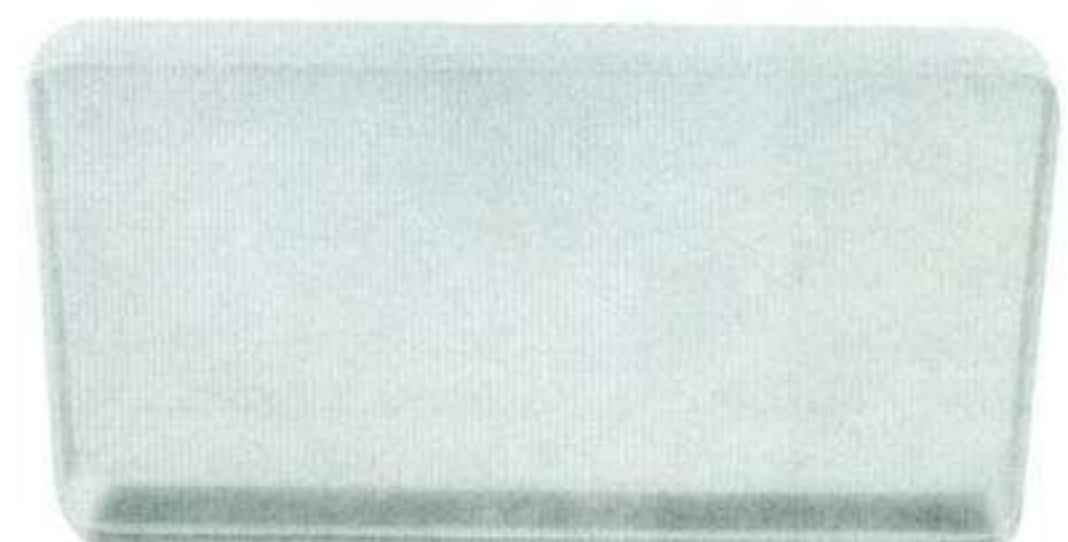

**07-320**

Solid Base: Dimensions 284-183-17mm





Excellence in Quality Instruments

If you need full catalogue please contact us

### Praise Corporation

Address : Muslim Town, Airport Road Kotli Behramm Sialkot 51310  
Pakistan.

Tel : +92-52-4273725

+92-52-4273723

+92-52-4264934

Cell / Whatsapp : +92 301 8606300

Fax : +92-52-4262310

Email : info@praise.com.pk

Muhammad Afzal Mughal (Director)

Email : afzal@praise.com.pk

