



Excellence in Quality Instruments

2021
EDITION



GENERAL SURGERY INSTRUMENTS

www.praise.com.pk



■ **MESSAGE FROM CEO**

Praise, being one of the leading manufacturer and exporter of Surgical Instruments in Sialkot Pakistan, had put together year's of hard work and dedication in adding more and more instruments in the range.

It is our pride to have credit of almost 25 years of experience in this business. We have the privilege to be the manufacturing pioneers of all kinds of instruments which are of highest quality. We have all the required Certifications like ISO 9001:2008, ISO 13485:2003 + AC 2009, cGMP (FDA) and CE.

At Praise, we endeavor to come up to our customer's satisfaction through quality, efficiency, reliability, competitive prices and fast delivery.

Wish you all the best.

Muhammad Aslam

Instruments for Professionals



▪ ABOUT US

For over 25 years, Praise Corporation has been devoted to providing its customers with the highest quality surgical instruments. Praise, is committed to provide you with the highest quality surgical instruments.

We are the original equipment manufacturers (OEM) for surgical instruments. Our product depth covers thousands of instruments ranging from the typical instruments used in the clinic to sophisticated instruments required during surgeries. We deem, however, pertinent to submit further that the range and scope of our production activities is not limited only to our product literature. We can produce instruments even if not depicted in our catalogue. We receive samples or photos or references from the world-renowned company's catalogue.

QUALITY / INNOVATION

At Praise, the quality is set in motion through motivated specifications planning by trained technical personnel. The computer aided designing and imaging provide visual instruments a set configuration, which simplifies each aspect of instrument manufacturing.

QUALITY CERTIFICATIONS

We have all the required Certifications like ISO 9001:2008, ISO 13485:2003 + AC 2009, cGMP (FDA) and CE.

FUTURE ORIENTED

We are a forward-looking company, and are determined to cover more milestones so as to be the world leaders in our field in the days to come. We shall cooperate with you every way possible, and assure you to serve your business interests the best way possible.

COMMITMENT

Our commitment is to meet the changing needs of healthcare systems and to lead the industry by providing quality surgical instruments at competitive cost.

We understand the diverse needs of our customers and know that quality along with delivery times are the most important and common requirements of our customers from both the segments. This realization allows us to serve our customers in the most efficient and cost effective manner.

■ CONTENTS

01		Scalpels Skalpelle Bisturías	Page 01 to 05
02		Diagnostics Diagnostik Diagnóstico	Page 16 to 21
03		Trocars, Vaccination Impfen, Punktion Vacunación, Punción	Page 22 to 29
04		Anaesthesia Narkose Anestesia	Page 30 to 38
05		Scissors Scheren Tijeras	Page 39 to 81
06		Forceps Pinzetten Pinzas	Page 82 to 98
07		Artery Forceps Arterienklemmen Pinzas hemostáticas	Page 99 to 127
08		Cotton Swab Forceps Tupfer-und Kornzangen Pinzas para tapones y curaciones	Page 128 to 131
09		Suture Naht Sutura	Page 132 to 162
10		Probes, Applicators, Spatulas Sonden, Watteträger, Spatel Sondas, Porta-algodones, Espátulas	Page 163 to 168
11		Retractors Wundhaken und -sperrer Separadores	Page 169 to 217
12		Bone Surgery Knochenchirurgie Cirugía ósea	Page 218 to 291
13		Plaster Instruments Plaster Instrumente Instrumentos de yeso	Page 292 to 294

Page 295 to 334	Cardiovascular Surgery Herz- und Gefäßchirurgie Cirugía cardiovascular		14
Page 335 to 365	Neurosurgery Neurochirurgie Neuro Cirugía		15
Page 366 to 396	Ophthalmology Ophthalmologie Oftalmología		16
Page 397 to 414	Otology Otologie Otología		17
Page 415 to 439	Rhinology Rhinologie Rinología		18
Page 440 to 444	Oral Instruments Mund instrumente Cirugía oral		19
Page 445 to 451	Tonsil Mandel Amígdala		20
Page 452 to 456	Tracheotomy Tracheotomie Traqueotomía		21
Page 457	Goitre Kropfchirurgie Bocio		22
Page 458 to 459	Dermatology Dermatologie Dermatología		23
Page 460 to 481	Stomach, Intestine, Rectum Magen, Darm, Mastdarm Estómago, Intestinos, Recto		24
Page 482 to 495	Kidney, Liver, Gall Stone, Urology Niere, Leber, Galle, Urologie Riñón, Hígado, Bilis, Urología		25
Page 496 to 535	Gynecology Gynäkologie Ginecología		26

■ CONTENTS

27		Obstetrics Geburtshilfe Obstetricia	Page 536 to 542
28		Sterilization Sterilisation Esterilización	Page 543 to 544
29		Asepsis Asepsis Asepsia	Page 545 to 546
30		Hollowware Holloware Hollowware	Page 547 to 552

01

Scalpels

Skalpelle

Bisturíes

Page 1 to 15



SCALPELS



Standard
 01-0100-03 # 3

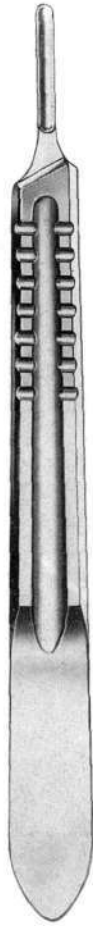

01-0101-03 # 3



01-0102-03 # 3



01-0103-3L # 3L
 01-0103-3XL # 3XL

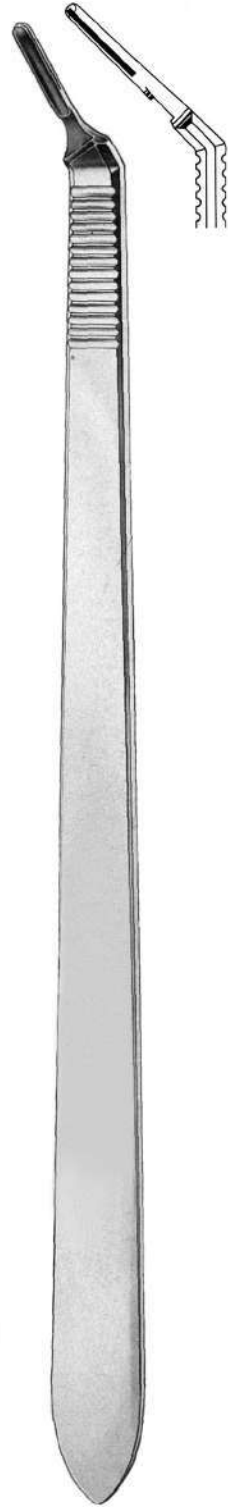

01-0104-3L # 3L
 01-0104-3XL # 3XL
 angled

SCALPELS



Standard
 01-0105-04 # 4

01-0106-4L # 4L
 01-0106-4XL # 4XL

01-0107-4L # 4L
 01-0107-4XL # 4XL
 angled

01-0108-07 # 7

01-0109-07 # 7K

Collin
 01-0110-08

Instruments for Professionals

02

Diagnostics

Diagnostik

Diagnóstico

Page 16 to 21

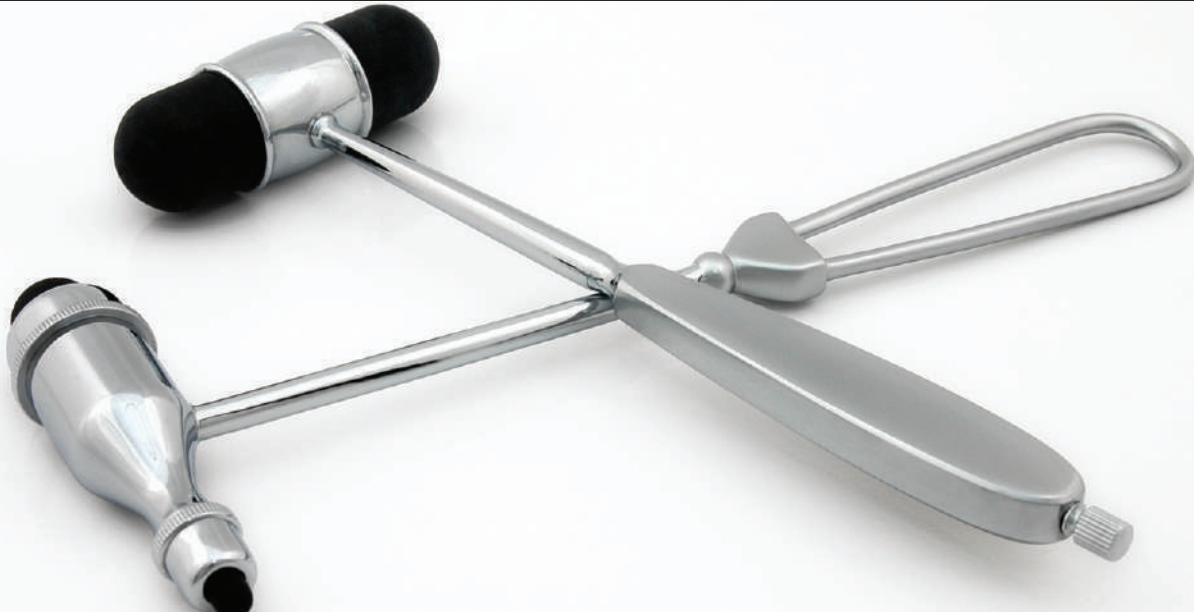

DIAGNOSTIC INSTRUMENTS

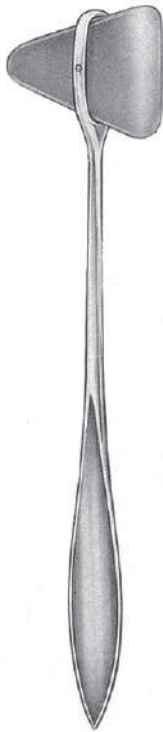

Taylor
 02-0200-18 18.0cm
 02-0200-20 20.0cm



Dejerine
 02-0201-20 20.0cm



Dejerine
 02-0202-21 21.0cm
 02-0202-35 35.0cm



Neuro-Duoflex
 02-0203-22 22.0cm

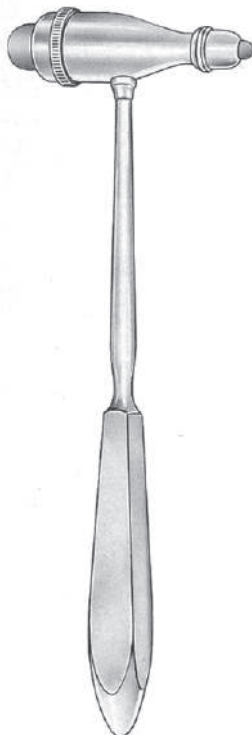

Troemner
 02-0204-24 24.0cm

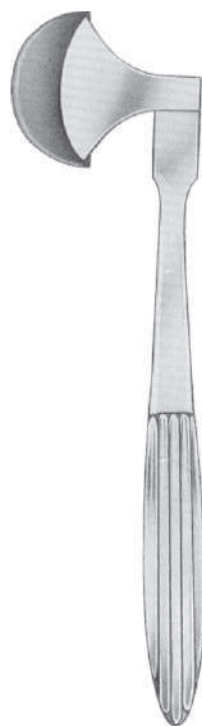

Berliner
 02-0205-20
 20cm/8"



Buck
 02-0206-18 18.0cm



Buck (Telescopic)
 02-0207-18 18.0cm

DIAGNOSTIC INSTRUMENTS

Goniometer

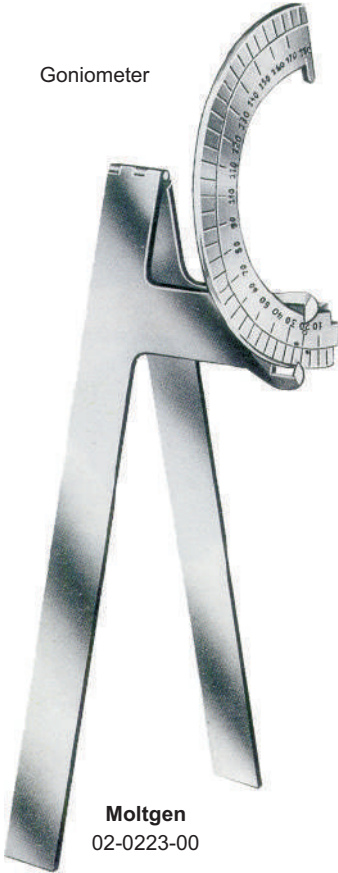

Moltgen
02-0223-00

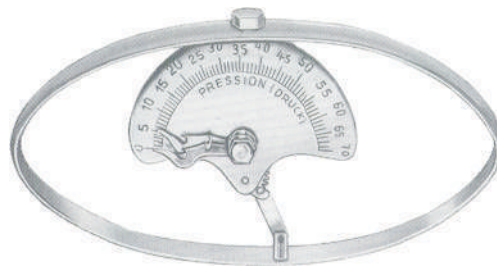

Collin
for children 02-0224-01 for adults 02-0224-02



Townley
02-0225-10
10cm/4"

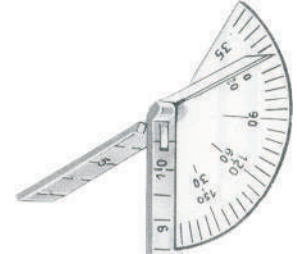

Caroll
02-0226-14
14cm/5½"



Chest piece only
02-0227-01

Ford
02-0227-00



Chest piece only
02-0228-01

Dual
02-0228-00

03

**Trocars, Vaccination
Impfen, Punktion
Vacunación, Punción**

Page 22 to 29

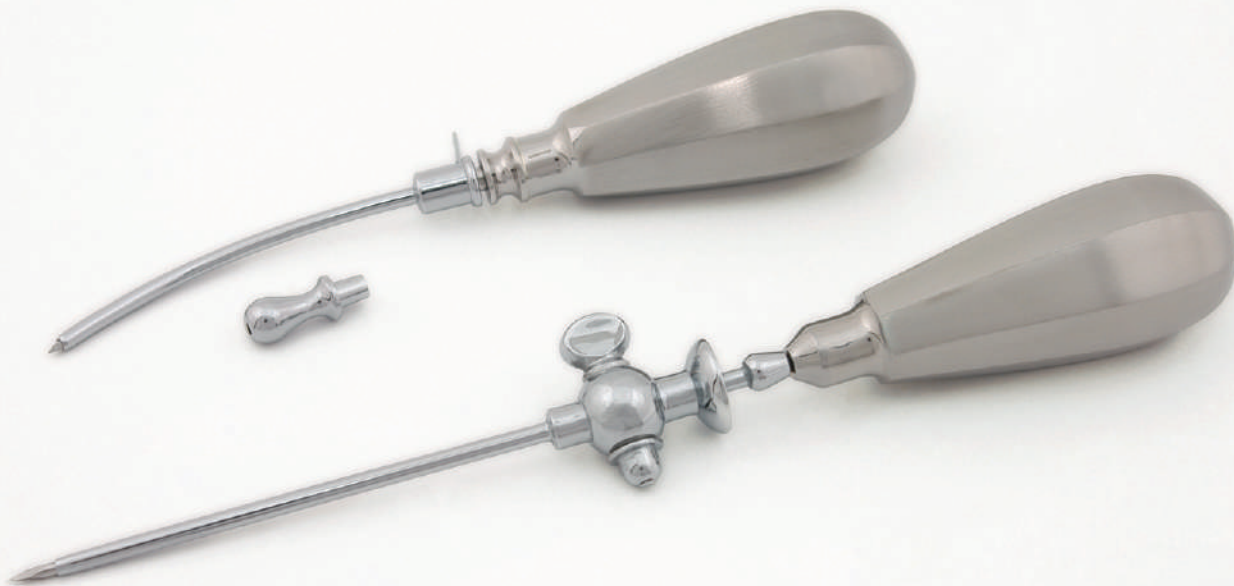

TROCARS AND VACCINATION



Nelson
 Ø mm 21cm/8¼"
 7.5 03-0256-07
 9.0 03-0256-09
 10.5 03-0256-10
 12.0 03-0256-12



Ochsner
 Ø mm 14.5cm/5½"
 4.0 03-0257-40
 4.6 03-0257-46
 5.5 03-0257-55
 6.5 03-0257-65

Ø5.5 mm



Krause
 03-0258-15
 15cm/6"

Ø2.25 mm

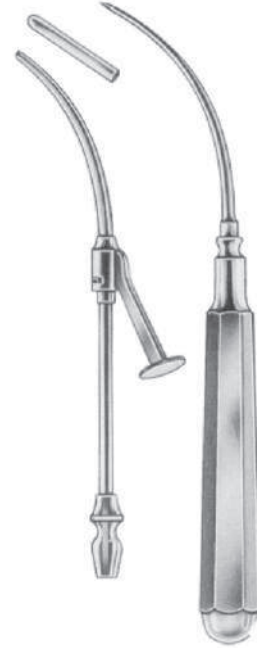

Coakley
 03-0259-16
 16cm/6¼"

Ø1.8 mm



Lichtwitz
 03-0260-19
 19cm/7½"

Ø3 mm



Douglas
 03-0261-11
 11.5 cm/4½"



03-0262-11
 11.5 cm/4½"



Pierce
 Ø mm
 3.0 03-0263-03
 4.0 03-0263-04
 5.0 03-0263-05

TROCARS AND VACCINATION

∅ 2 mm



Landau
 03-0271-16
 16cm/6¼"

∅ 2 mm



Landau
 03-0272-19
 19cm/7½"

∅ 13.5mm



Peau
 03-0273-16
 16cm/6¼"

∅ 8 mm

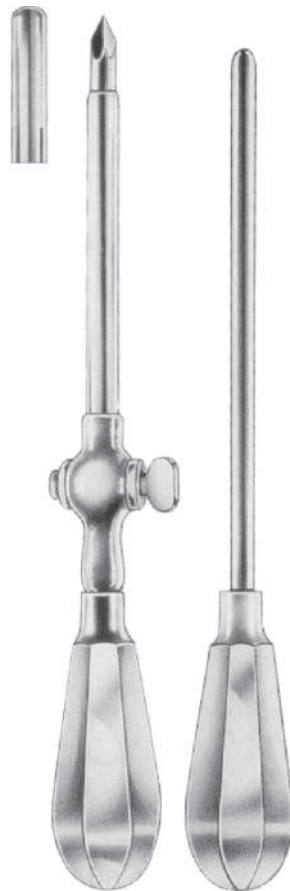

Buelau
 03-0274-24
 24cm/9½"

04

Anaesthesia

Narkose

Anestesia

Page 30 to 38



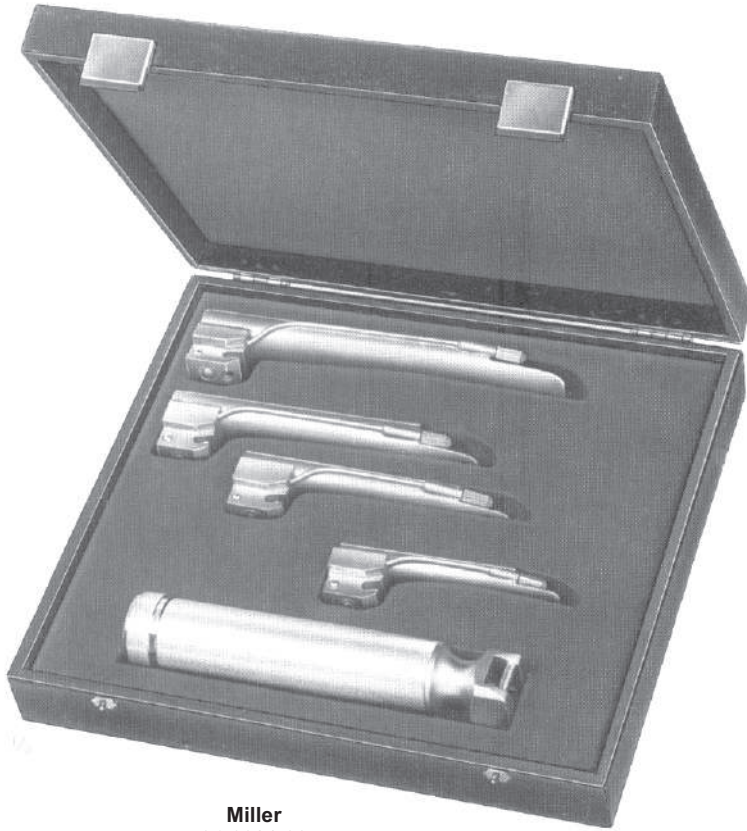

Miller
 04-0321-30
 04-0321-40

04-0321-30
 Laryngoscope Set
 Consisting of:
 04-0321-00 Battery Handle (without batteries)
 04-0321-11 McIntosh blade, Fig 1
 04-0321-12 ditto, Fig 2
 04-0321-13 ditto, Fig 3

04-0321-40
 Laryngoscope Set
 Consisting of:
 04-0321-00 Battery Handle (without batteries)
 04-0321-11 McIntosh blade, Fig 1
 04-0321-12 McIntosh blade, Fig 2
 04-0321-13 McIntosh blade, Fig 3
 04-0321-14 McIntosh blade, Fig 4

McIntosh Laryngoscope Blades
 04-0321-10 Fig 0, Working length 55mm, baby's
 04-0321-11 Fig 1, Working length 75mm, children's
 04-0321-12 Fig 2, Working length 90mm, adolescent's
 04-0321-13 Fig 3, Working length 110mm, women's
 04-0321-14 Fig 4, Working length 135mm, men's

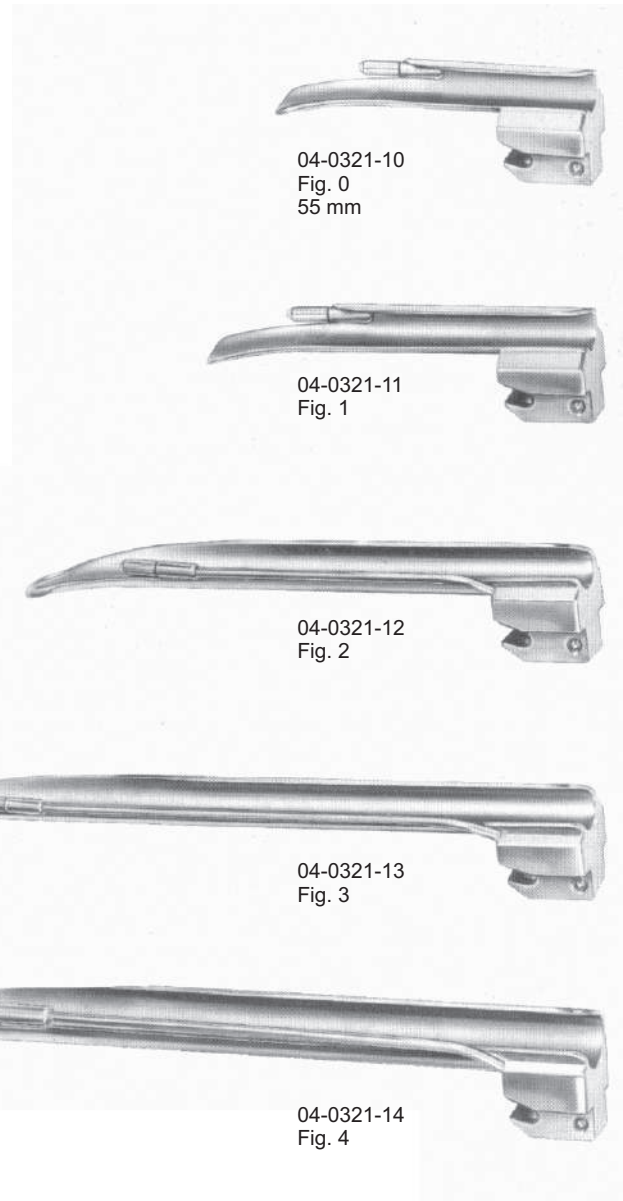

04-0321-10
 Fig. 0
 55 mm

04-0321-11
 Fig. 1

04-0321-12
 Fig. 2

04-0321-13
 Fig. 3

04-0321-14
 Fig. 4



McIntosh
 04-0322-30
 04-0322-40



04-0322-10

04-0322-11



04-0322-12



04-0322-13



04-0322-14

04-0322-30
 Laryngoscope Set
 Consisting of:
 04-0322-00 Battery Handle (without batteries)
 04-0322-11 McIntosh blade, Fig 1
 04-0322-12 ditto, Fig 2
 04-0322-13 ditto, Fig 3

04-0322-40
 Laryngoscope Set
 Consisting of:
 04-0322-00 Battery Handle (without batteries)
 04-0322-11 McIntosh blade, Fig 1
 04-0322-12 McIntosh blade, Fig 2
 04-0322-13 McIntosh blade, Fig 3
 04-0322-14 McIntosh blade, Fig 4

McIntosh Laryngoscope Blades
 04-0322-10 Fig 0, Working length 55mm, baby's
 04-0322-11 Fig 1, Working length 75mm, children's
 04-0322-12 Fig 2, Working length 90mm, adolescent's
 04-0322-13 Fig 3, Working length 110mm, women's
 04-0322-14 Fig 4, Working length 135mm, men's

05

Scissors

Scheren

Tijeras

Page 39 to 81



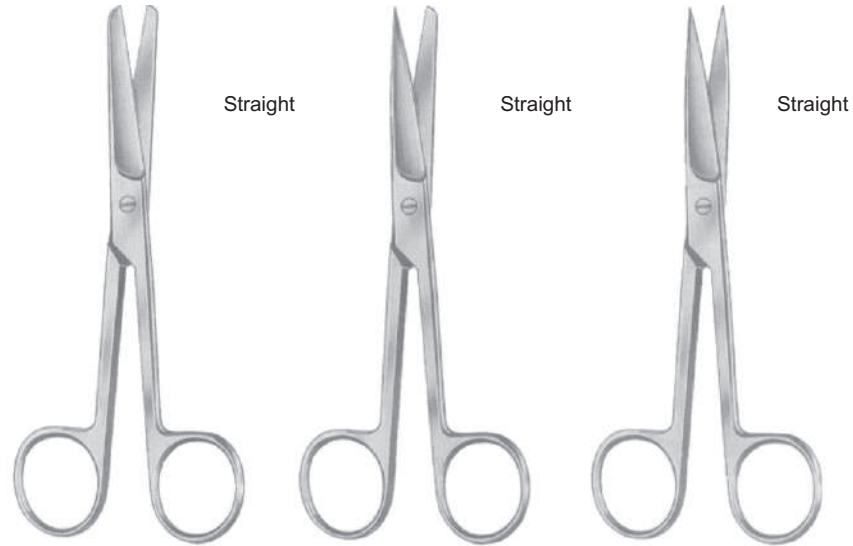

Straight

Straight

Straight

Standard
Fig. 1

Standard
Fig. 2

Standard
Fig. 3

10.0	cm/4"	05-0401-10
11.5	cm/4½"	05-0401-11
13.0	cm/5"	05-0401-13
14.5	cm/5¾"	05-0401-14
15.5	cm/6"	05-0401-15
16.0	cm/6¼"	05-0401-16
18.0	cm/7"	05-0401-18
20.0	cm/8"	05-0401-20

05-0402-10	05-0403-10
05-0402-11	05-0403-11
05-0402-13	05-0403-13
05-0402-14	05-0403-14
05-0402-15	05-0403-15
05-0402-16	05-0403-16
05-0402-18	05-0403-18
05-0402-20	05-0403-20

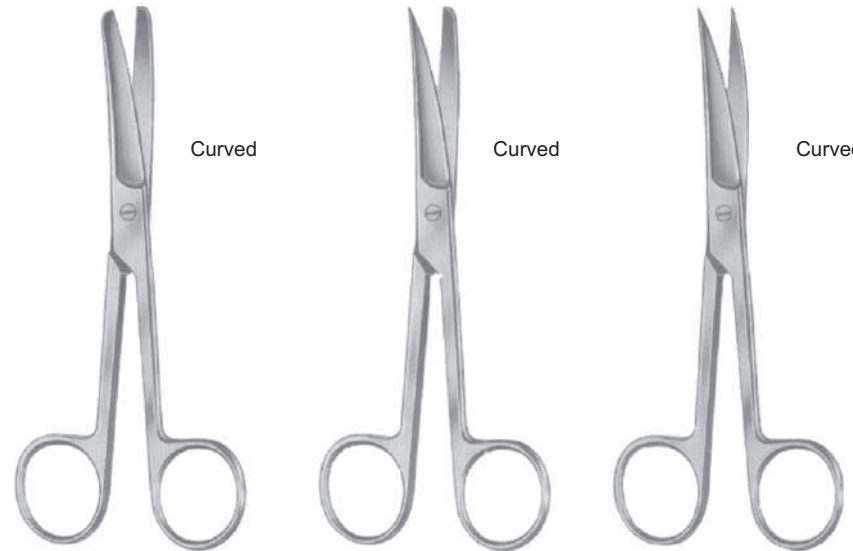

Curved

Curved

Curved

Standard
Fig. 1

Standard
Fig. 2

Standard
Fig. 3

10.0	cm/4"	05-0404-10
11.5	cm/4½"	05-0404-11
13.0	cm/5"	05-0404-13
14.5	cm/5¾"	05-0404-14
15.5	cm/6"	05-0404-15
16.0	cm/6¼"	05-0404-16
18.0	cm/7"	05-0404-18
20.0	cm/8"	05-0404-20

05-0405-10	05-0406-10
05-0405-11	05-0406-11
05-0405-13	05-0406-13
05-0405-14	05-0406-14
05-0405-15	05-0406-15
05-0405-16	05-0406-16
05-0405-18	05-0406-18
05-0405-20	05-0406-20

06

Forceps
Pinzetten
Pinzas

Page 82 to 98



FORCEPS



Standard

Standard

06-1001-10	10.5cm
06-1001-11	11.5cm
06-1001-13	13.0cm
06-1001-14	14.5cm
06-1001-16	16.0cm
06-1001-18	18.0cm
06-1001-20	20.0cm
06-1001-23	23.0cm
06-1001-25	25.0cm
06-1001-30	30.0cm



Narrow

06-1002-10	10.5cm
06-1002-11	11.5cm
06-1002-13	13.0cm
06-1002-14	14.5cm
06-1002-16	16.0cm
06-1002-18	18.0cm
06-1002-20	20.0cm
06-1002-23	23.0cm
06-1002-25	25.0cm
06-1002-30	30.0cm



USA Model



06-1003-12	12.0cm
06-1003-13	13.0cm
06-1003-14	14.5cm
06-1003-15	15.0cm
06-1003-18	18.0cm
06-1003-21	21.0cm
06-1003-25	25.0cm
06-1003-31	31.0cm



06-1004-12	12.0cm
06-1004-13	13.0cm
06-1004-14	14.5cm
06-1004-15	15.0cm
06-1004-18	18.0cm
06-1004-21	21.0cm
06-1004-25	25.0cm



Stille
06-1005-15
15.0cm



Ochsner
06-1006-14
14.0cm



Treves
Turn over
06-1007-12 12.0cm
06-1007-15 15.0cm
06-1007-18 18.0cm
06-1007-20 20.0cm
06-1007-25 25.0cm

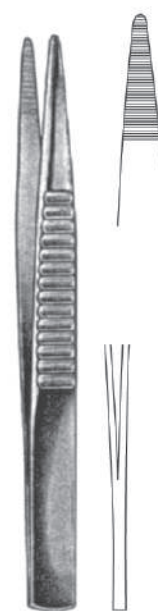

Treves
Block end
06-1008-12 12.0cm
06-1008-15 15.0cm
06-1008-18 18.0cm
06-1008-20 20.0cm
06-1008-25 25.0cm

FORCEPS



Cushing
 06-1009-17 17.0cm 06-1010-17



Potts Smith
 06-1011-18 18.0cm
 06-1011-21 21.0cm
 06-1011-25 25.0cm
 06-1011-30 30.0cm



Waugh
 06-1012-15 15.0cm
 06-1012-18 18.0cm
 06-1012-20 20.0cm



Brophy
 06-1013-20 20.0cm 06-1014-20

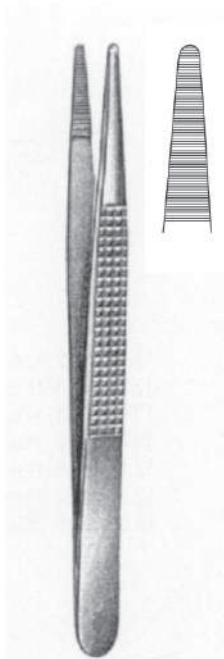

Bonney
 06-1015-17
 17.5cm



Ramsey
 06-1016-18
 18.0cm



Duehrssen
 06-1017-20
 20.0cm



Wangensteen
 06-1018-23
 23.0cm

07

**Artery Forceps
Arterienklemmen
Pinzas hemostáticas**

Page 99 to 127



ARTERY FORCEPS



Terrier
 07-1201-10 10 cm/4"



Pennington
 07-1202-15 15 cm/6"
 07-1202-20 20 cm/8"



Peau
 07-1203-12 12.5 cm/5"

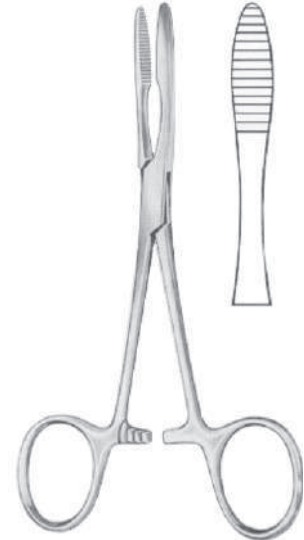

Peau
 07-1204-14 14 cm/5 3/4"
 07-1204-16 16 cm/6 1/4"

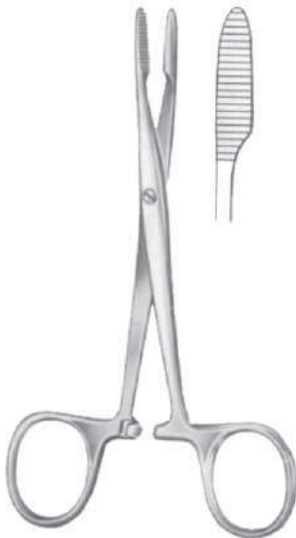

Peau
 07-1205-14 14 cm/5 1/2"

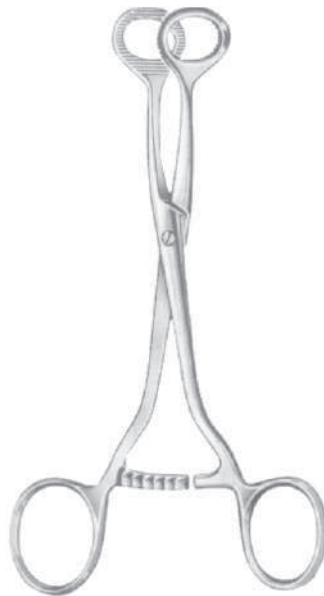

Collin
 07-1206-15 15.5 cm/6"



Collin
 07-1207-14 14 cm/5 1/2"



Collin
 07-1208-16 16.5 cm/6 1/2"

ARTERY FORCEPS



Halstead-Mosquito
 18 cm/7"
 21 cm/8¼"

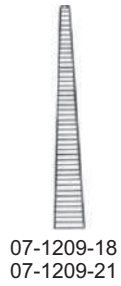

07-1209-18
 07-1209-21

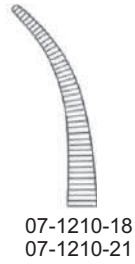

07-1210-18
 07-1210-21

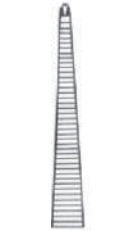

07-1211-18
 07-1211-21



07-1212-18
 07-1212-21



Halstead-Mosquito
 12 cm/4¾"
 14 cm/5½"



07-1213-12
 07-1213-14



07-1214-12
 07-1214-14

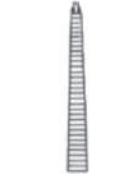

07-1215-12
 07-1215-14



07-1216-12
 07-1216-14



Micro-Mosquito
 10 cm/4"
 12 cm/4¾"



07-1217-10
 07-1217-12



07-1218-10
 07-1218-12



07-1219-10
 07-1219-12



07-1220-10
 07-1220-12



Jacobson-Halstead
 13 cm/5"

Very fine



07-1221-13



07-1222-13

08

Cotton Swab Forceps
Tupfer-und Kornzangen
Pinzas para tapones y curaciones

Page 128 to 131



COTTON SWAB FORCEPS



Ulrich

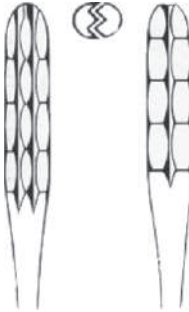

Straight

08-1451-22
 08-1451-25
 08-1451-27

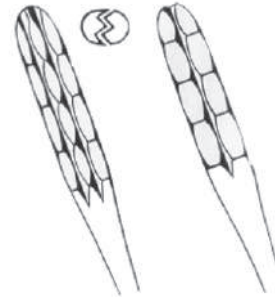

Curved

22 cm/8¾"
 25 cm/10"
 27 cm/10½"

08-1452-22
 08-1452-25
 08-1452-27



Lister

08-1453-13	13 cm/5"	08-1454-13
08-1453-15	15 cm/6"	08-1454-15
08-1453-18	18 cm/7"	08-1454-18



Bryant

08-1455-13
 13 cm/5"

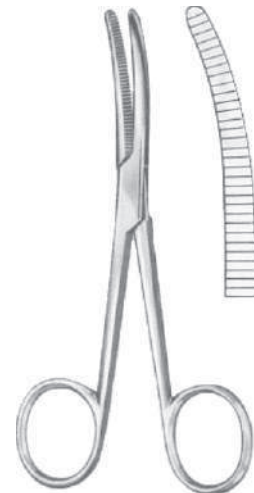

Bryant

08-1456-13
 13 cm/5"

COTTON SWAB FORCEPS



Collin
 08-1457-25
 25cm/10"



Cheron
 08-1458-25
 25cm/10"



Emmet
 08-1459-21
 21cm/8¼"



Bozemann
 08-1460-26
 26cm/10¼"



Bozemann
 26cm/10 ¼"



08-1461-26



Smooth

08-1462-26

COTTON SWAB FORCEPS



Gross-Maier

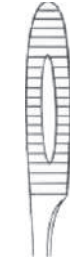

Straight



Curved

With Ratchet

08-1470-20	20 cm/8"	08-1471-20
08-1470-25	25 cm/10"	08-1471-25

Without Ratchet

08-1472-20	20 cm/8"	08-1473-20
08-1472-25	25 cm/10"	08-1473-25



Pelkmann
25 cm/10"



08-1474-25



08-1475-25



Sims-Maier
28 cm/11"



08-1476-28



08-1476-28A



Duplay
20 cm/8"



08-1477-20



08-1478-20

09

Suture

Naht

Sutura

Page 132 to 162



SUTURE INSTRUMENTS



Derf
 09-1501-12 12.0cm

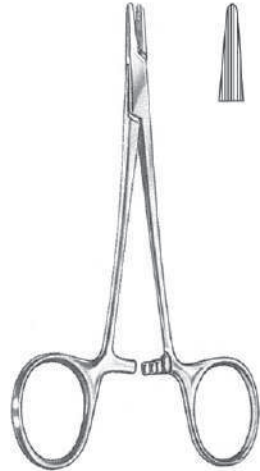

Derf
 09-1502-12 12.5cm

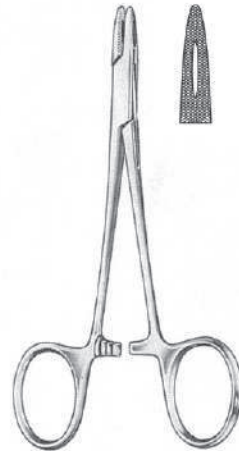

Collier
 09-1503-12 12.5cm

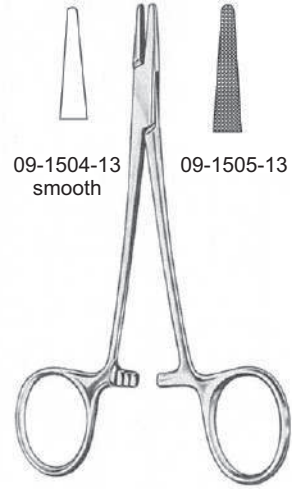

Webster
 13.0cm

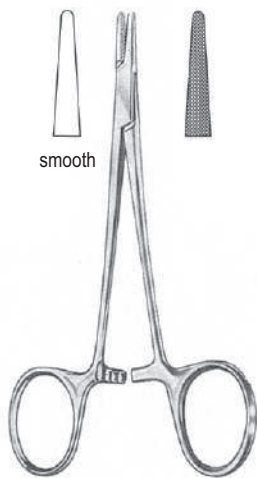

Halsey
 09-1506-13 13.0cm 09-1507-13



Neivert
 09-1508-13 13.0cm



Hegar-Baumgartner
 09-1509-12 12.5cm
 09-1509-14 14.0cm



Brown
 09-1510-13 13.0cm
 09-1510-18 18.0cm

Instruments for Professionals

SUTURE INSTRUMENTS



Mayo-Hegar

- | | |
|-------------------|------------|
| 09-1511-14 14.0cm | 09-1512-14 |
| 09-1511-15 15.0cm | 09-1512-15 |
| 09-1511-16 16.0cm | 09-1512-16 |
| 09-1511-18 18.0cm | 09-1512-18 |
| 09-1511-20 20.0cm | 09-1512-20 |
| 09-1511-22 22.0cm | 09-1512-22 |
| 09-1511-24 24.0cm | 09-1512-24 |
| 09-1511-26 26.0cm | 09-1512-26 |
| 09-1511-28 28.0cm | 09-1512-28 |
| 09-1511-30 30.0cm | 09-1512-30 |



delicate pattern

Mayo-Hegar

- | |
|-------------------|
| 09-1513-16 16.0cm |
| 09-1513-18 18.0cm |
| 09-1513-20 20.0cm |



Crile-Murray

- | |
|-------------------|
| 09-1514-15 15.0cm |
|-------------------|



Crile-Wood

- | |
|-------------------|
| 09-1515-15 15.0cm |
| 09-1515-18 18.0cm |
| 09-1515-20 20.0cm |

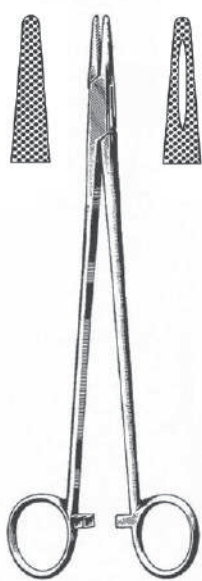

Hegar

- | | |
|-------------------|------------|
| 09-1516-20 20.0cm | 09-1517-20 |
| 09-1516-24 24.0cm | 09-1517-24 |

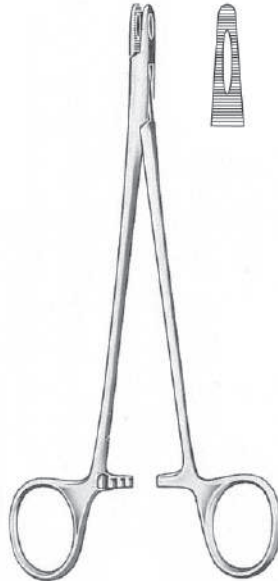

Adson

- | |
|-------------------|
| 09-1518-18 18.0cm |
|-------------------|



Heaney

- | |
|-------------------|
| 09-1519-21 21.0cm |
|-------------------|



Metzenbaum

- | |
|-------------------|
| 09-1520-18 18.0cm |
|-------------------|

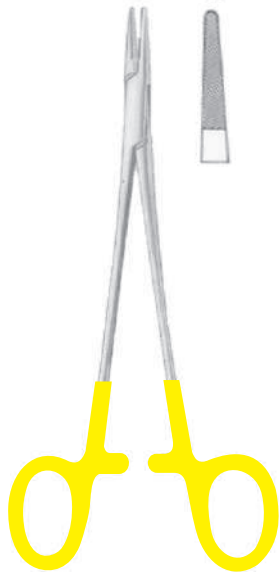

Baby-Crile-Wood
 09-1658-15
 15cm/6"

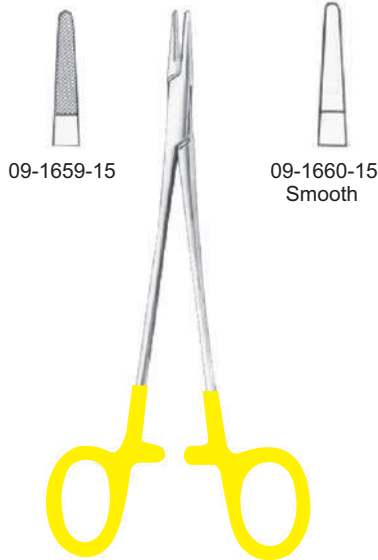

Crile-Wood
 15cm/6"

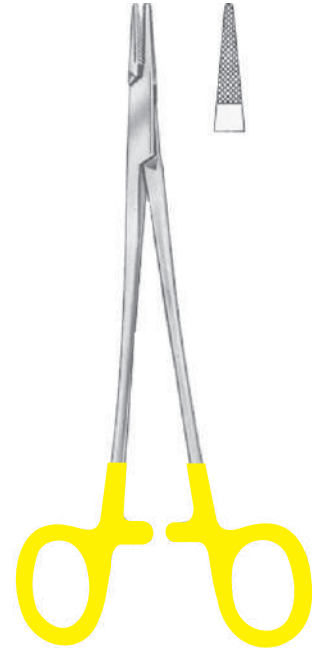

Crile-Wood

	cm	in
09-1661-18	18	7"
09-1661-20	20	8"
09-1661-23	23	9"
09-1661-26	26	10 1/4"
09-1661-31	31	12 1/4"

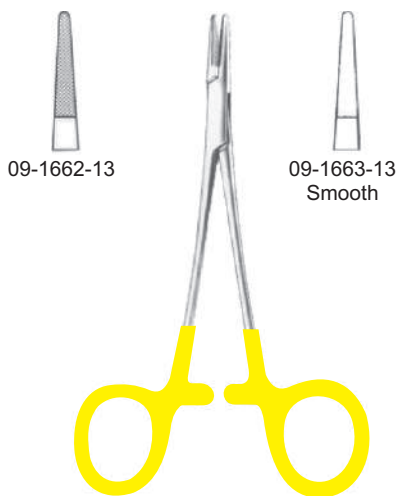

Halsey
 13cm/5"

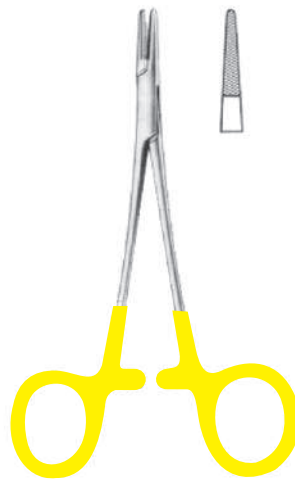

Converse
 09-1664-12
 12.5cm/5"

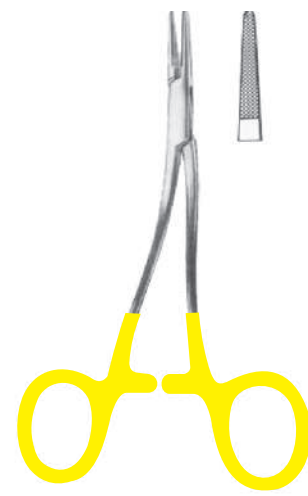

Kilner
 09-1665-13
 13.5cm/5 1/4"

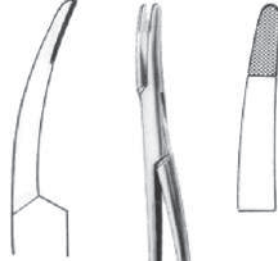

Stratte
 09-1671-23
 23cm/9"



Masson
 09-1672-27
 27cm/10½"



Wangenstein
 09-1673-27
 27cm/10½"



Finocchietto
 09-1674-20 20cm/8"
 09-1674-27 27cm/10½"

10

Probes, Applicators, Spatulas

Sonden, Watteträger, Spatel

Sondas, Porta-algodones, Espátulas

Page 163 to 168



PROBES, APPLICATORS, SPATULAS

Of tin



10-1765-25 25 cm/10"
 10-1765-30 30 cm/12"
 10-1765-40 40 cm/15¾"

Plaster spatulas



10-1766-13 13 cm/5"
 10-1766-14 14 cm/5½"



Pelteson
 10-1767-23
 23 cm/9"



Fein
 10-1768-28
 28 cm/11"



Buie
 10-1769-16
 16 cm/6¼"

Fistula probes



Lockhart-Mummy
 16.5 cm/6½"



Fig. 1
 10-1770-01



Fig. 2
 10-1770-02



Fig. 3
 10-1770-03



Fig. 4
 10-1770-04



Pratt
 21 cm/8¼"



10-1771-01



10-1771-02



10-1771-03

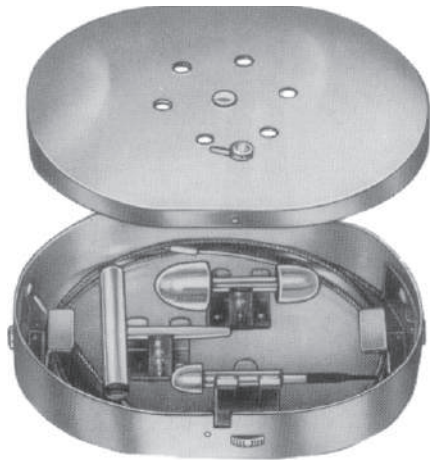

Sterilizable

Nabatoff
 10-1786-00
 135x100x25 mm

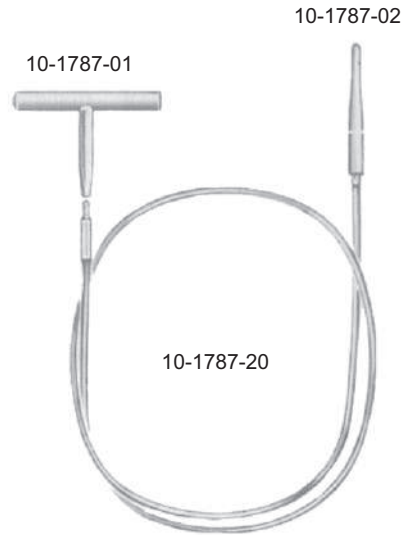

10-1787-01

10-1787-02

10-1787-20

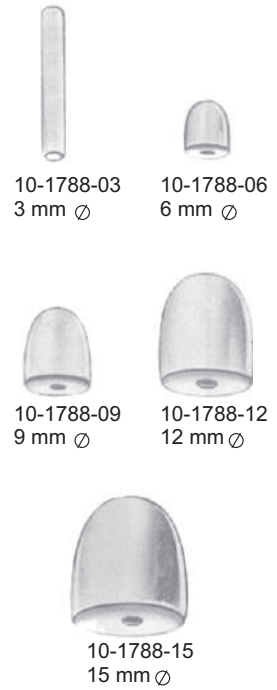

10-1788-03
 3 mm Ø

10-1788-06
 6 mm Ø

10-1788-09
 9 mm Ø

10-1788-12
 12 mm Ø

10-1788-15
 15 mm Ø

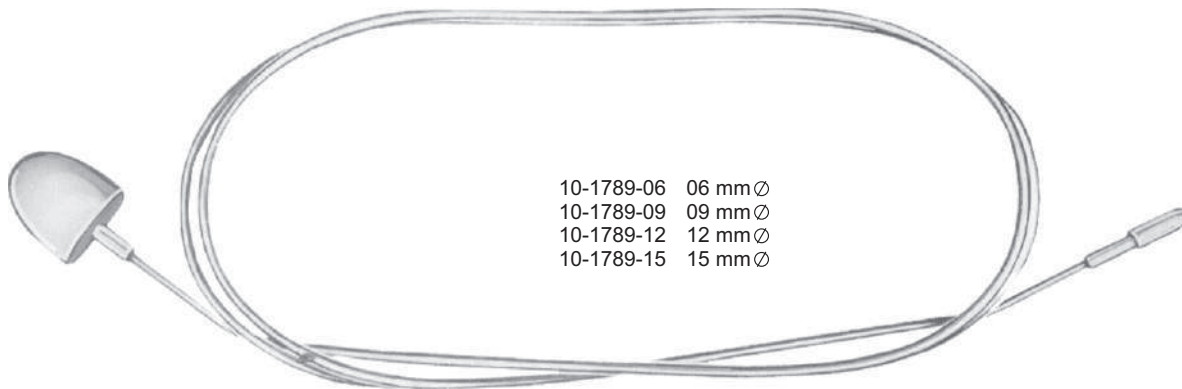

10-1789-06 06 mm Ø
 10-1789-09 09 mm Ø
 10-1789-12 12 mm Ø
 10-1789-15 15 mm Ø

Myers

11

Retractors

Wundhaken und -sperrer

Separadores

Page 169 to 217



RETRACTORS

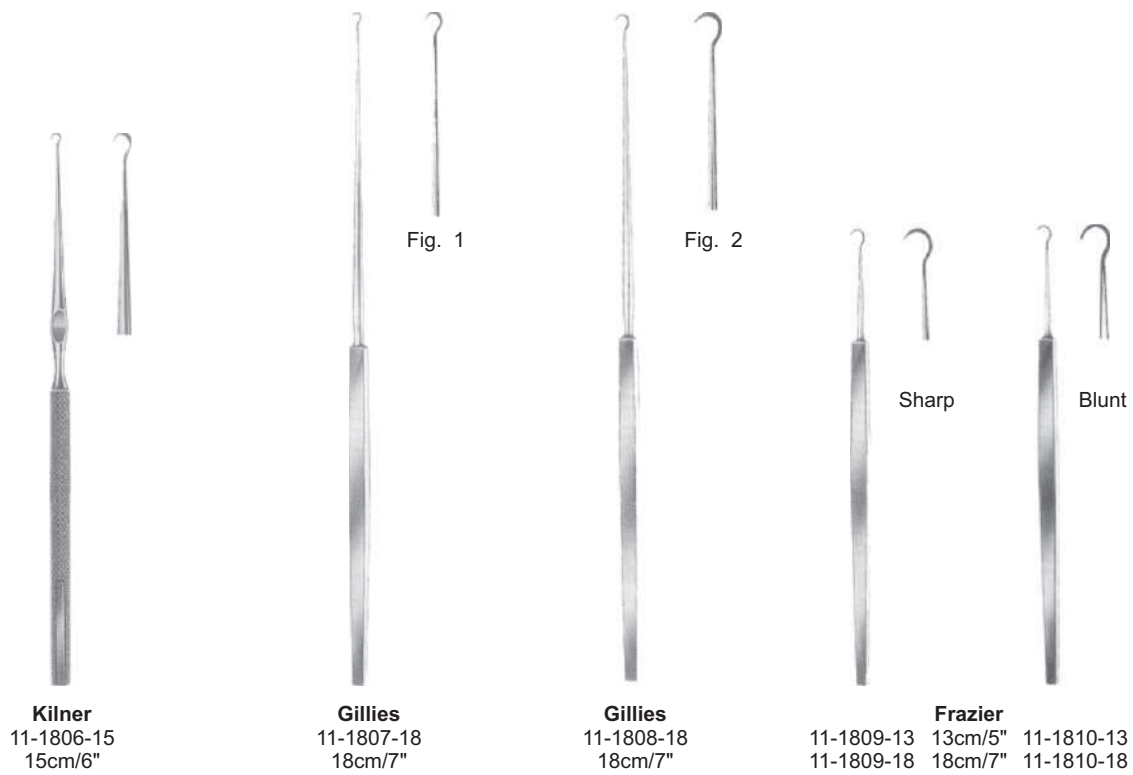
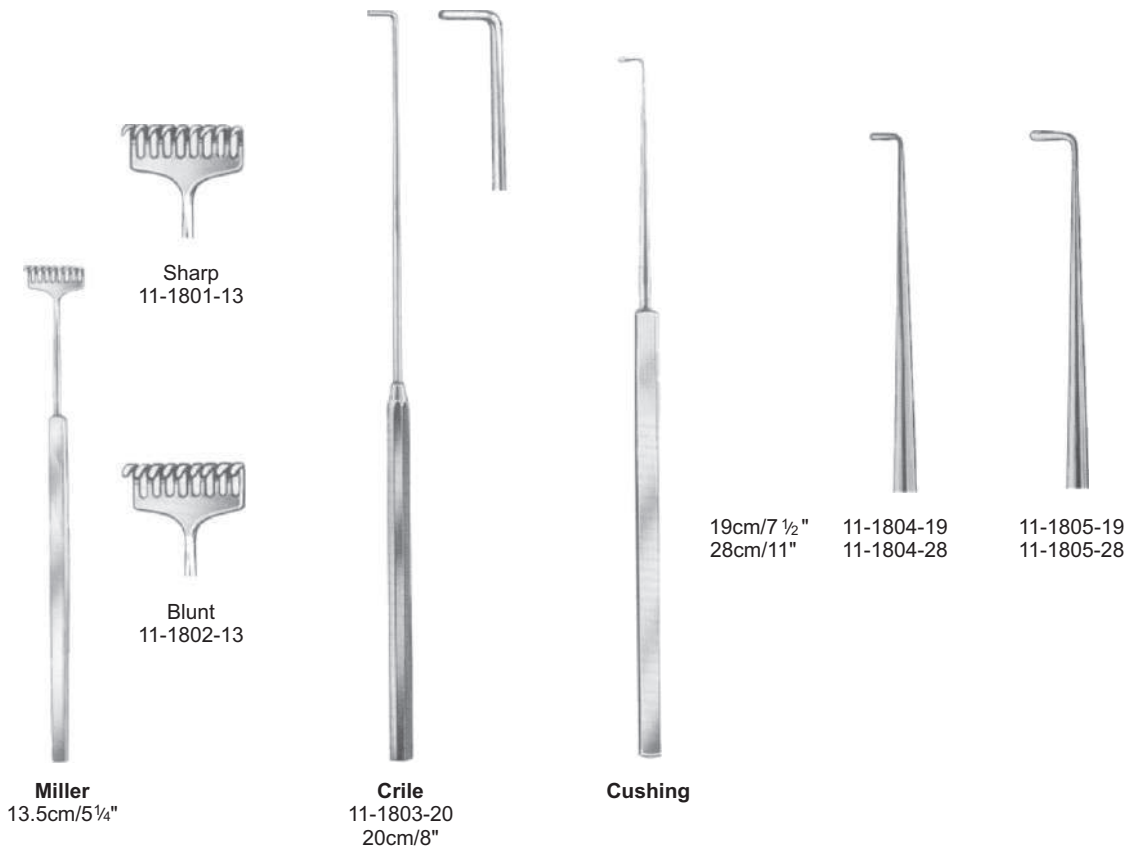

RETRACTORS



11-1811-16
 16cm/6¼"



11-1811-08
 8 mm



11-1811-10
 10 mm



11-1812-12
 12 mm



11-1812-14
 14 mm



11-1811-12
 12 mm



11-1811-14
 14 mm



11-1812-16
 16 mm



11-1812-18
 18 mm



11-1811-16
 16 mm



11-1811-18
 18 mm



Sharp

11-1813-16



Blunt

11-1814-16

Graefe

16cm/6¼"



11-1815-16
 16cm/6¼"



11-1816-16
 16cm/6¼"



O, Connor
 11-1817-16
 16cm/6¼"



11-1818-16



Guthrie
 16cm/6¼"



11-1820-16
 16cm/6¼"



11-1821-16
 16cm/6¼"

12

Bone Surgery
Knochenchirurgie
Cirurgía ósea

Page 218 to 291





Mead
 12-2201-17 17.0cm
 26mm Ø,320 g (11¼ oz)



Partsch
 12-2202-18 18.0cm
 22mm Ø,200 g (7 oz)

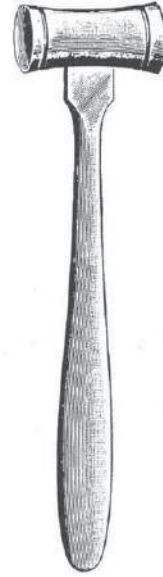

12-2203-30
 30mm Ø,510 g

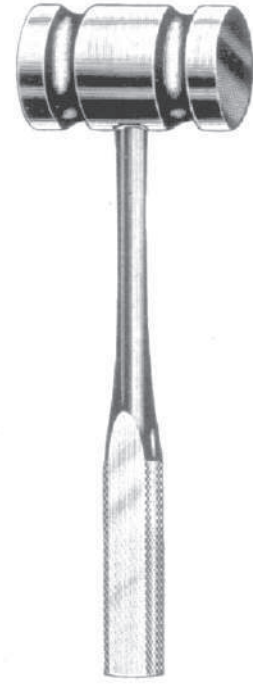

12-2204-25 250 g
 12-2205-45 450 g
 12-2206-90 900 g
 26.5cm

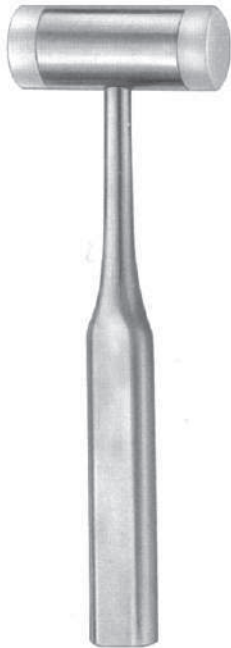

12-2207-18 18.5cm
 25mm Ø 135 g



lead filled

12-2208-19 19.0cm
 22mm Ø 155 g



Hajek
 12-2209-22 22.0cm
 27mm Ø 130 g

BONE SURGERY

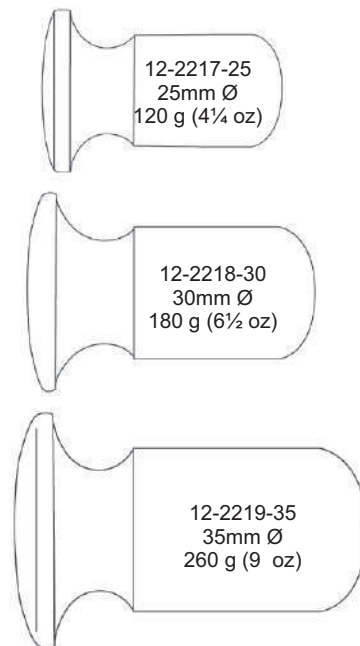
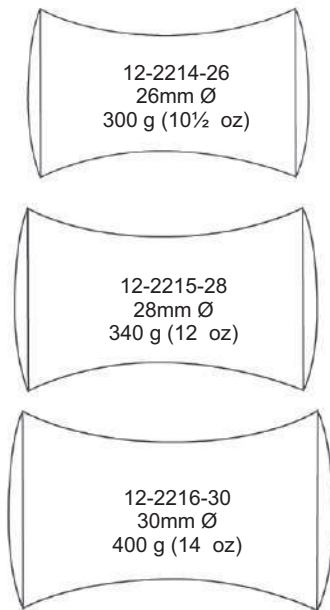
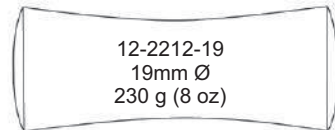
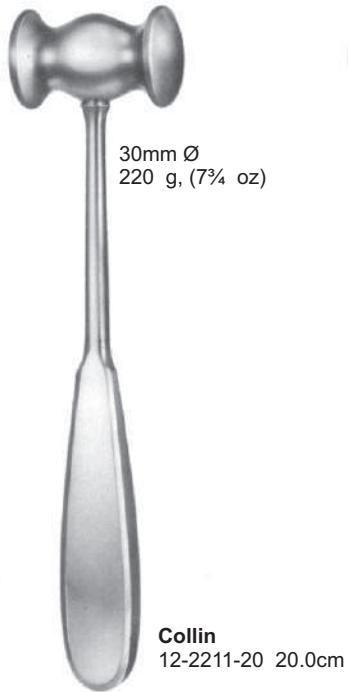

13

**Plaster Instruments
Plaster Instrumente
Instrumentos de yeso**

Page 292 to 294



PLASTER INSTRUMENTS



13-2701-20 20.0cm



Seutin
 13-2702-23 23.0cm



Bruns
 13-2703-24 24.0cm



Bruns (serrated)
 13-2704-24 24.0cm



Stille-Mini
 13-2705-20 20.0cm



Stille
 13-2706-20 20.0cm
 13-2706-23 23.0cm
 13-2706-26 26.0cm
 13-2706-30 30.0cm
 13-2706-37 37.0cm



Stille
 13-2707-24 24.0cm

PLASTER INSTRUMENTS



Haglund-Stille
 13-2708-28 28.0cm



USA Mod Spreader
 13-2709-23 23.0cm



Wolff-Boehler
 13-2710-18 18.0cm
 13-2710-20 20.0cm
 13-2710-22 22.0cm
 13-2710-24 24.0cm
 13-2710-26 26.0cm



Hennig
 13-2711-28
 28.0cm



Beeson
 13-2712-30
 30.0cm

14

**Cardiovascular Surgery
Herz- und Gefäßchirurgie
Cirugía cardiovascular**

Page 295 to 334

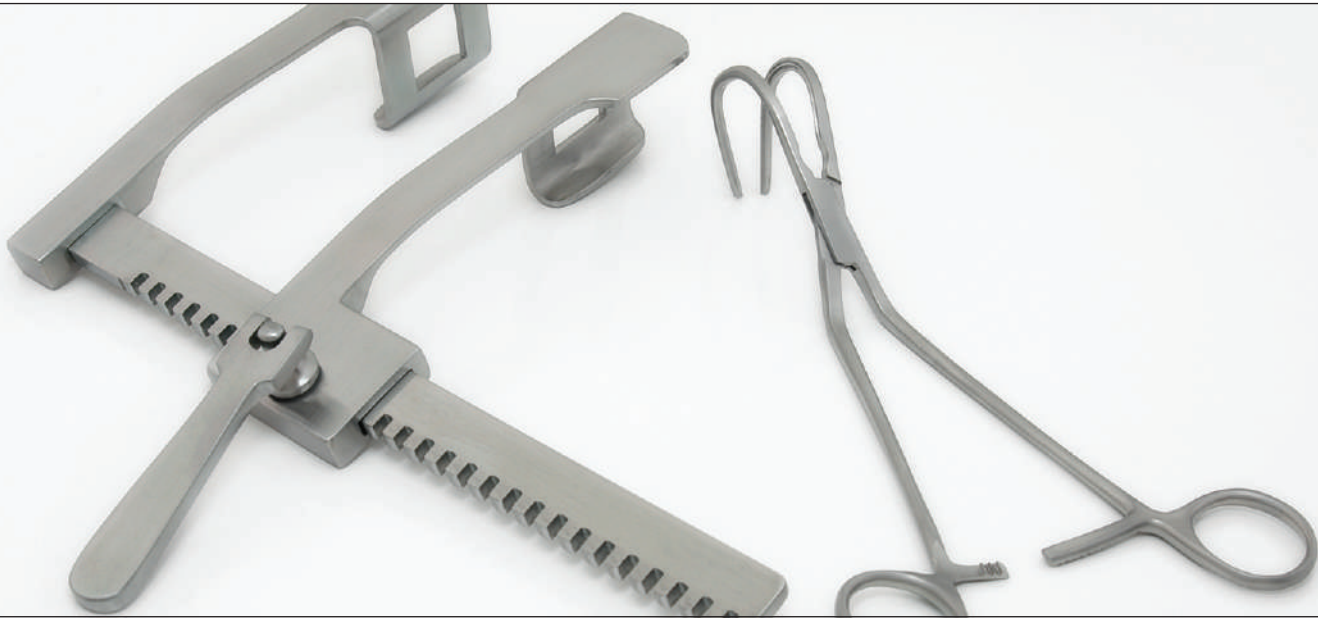



1.5mm

14-2801-12 12.5cm



1.0mm

14-2802-15 15.0cm
 14-2802-18 18.0cm



1.2mm

14-2803-15 15.0cm
 14-2803-18 18.0cm
 14-2803-24 24.0cm

DEBAKEY-ADSON

DEBAKEY-GERALD



1.0mm

14-2804-18 18.0cm



1.0mm

14-2805-15 15.0cm 14-2806-15
 14-2805-19 19.0cm 14-2806-19
 14-2805-24 24.0cm 14-2806-24



1.5mm



1.0mm

14-2807-15 15.0cm
 14-2807-19 19.0cm
 14-2807-24 24.0cm

DEBAKEY-CUSHING

DEBAKEY-DIETRICH

DEBAKEY-LIGHT

CARDIOVASCULAR INSTRUMENTS

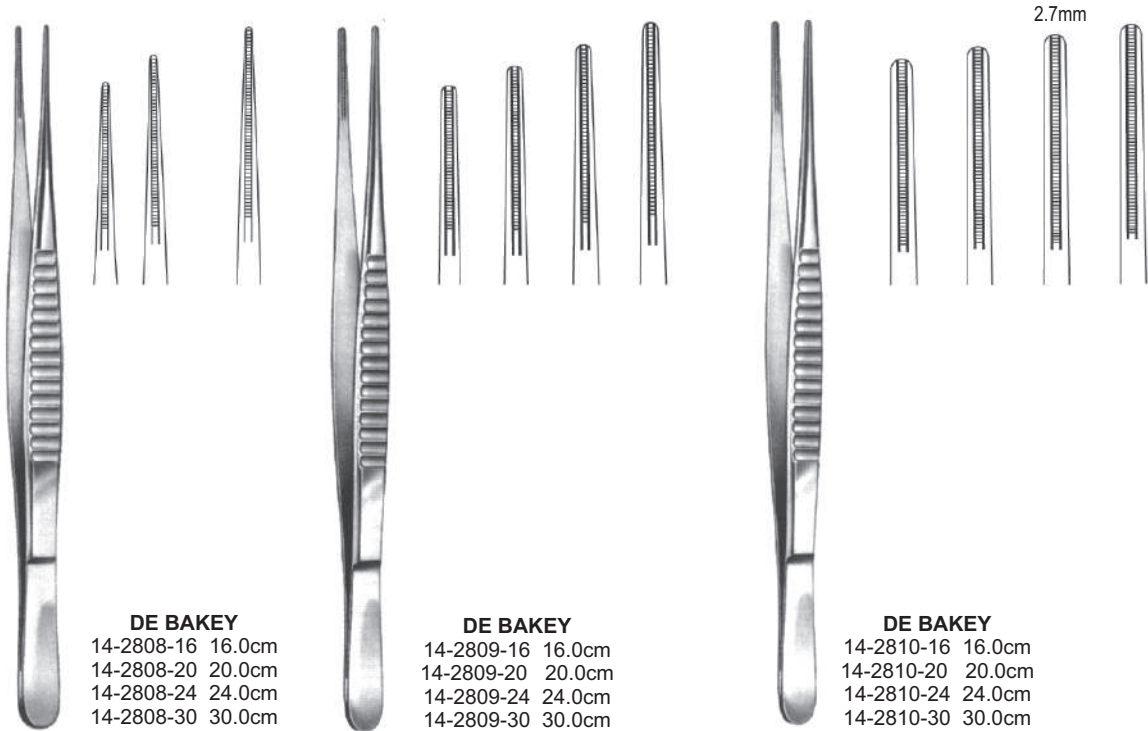

DE BAKEY
 14-2808-16 16.0cm
 14-2808-20 20.0cm
 14-2808-24 24.0cm
 14-2808-30 30.0cm

DE BAKEY
 14-2809-16 16.0cm
 14-2809-20 20.0cm
 14-2809-24 24.0cm
 14-2809-30 30.0cm

DE BAKEY
 14-2810-16 16.0cm
 14-2810-20 20.0cm
 14-2810-24 24.0cm
 14-2810-30 30.0cm

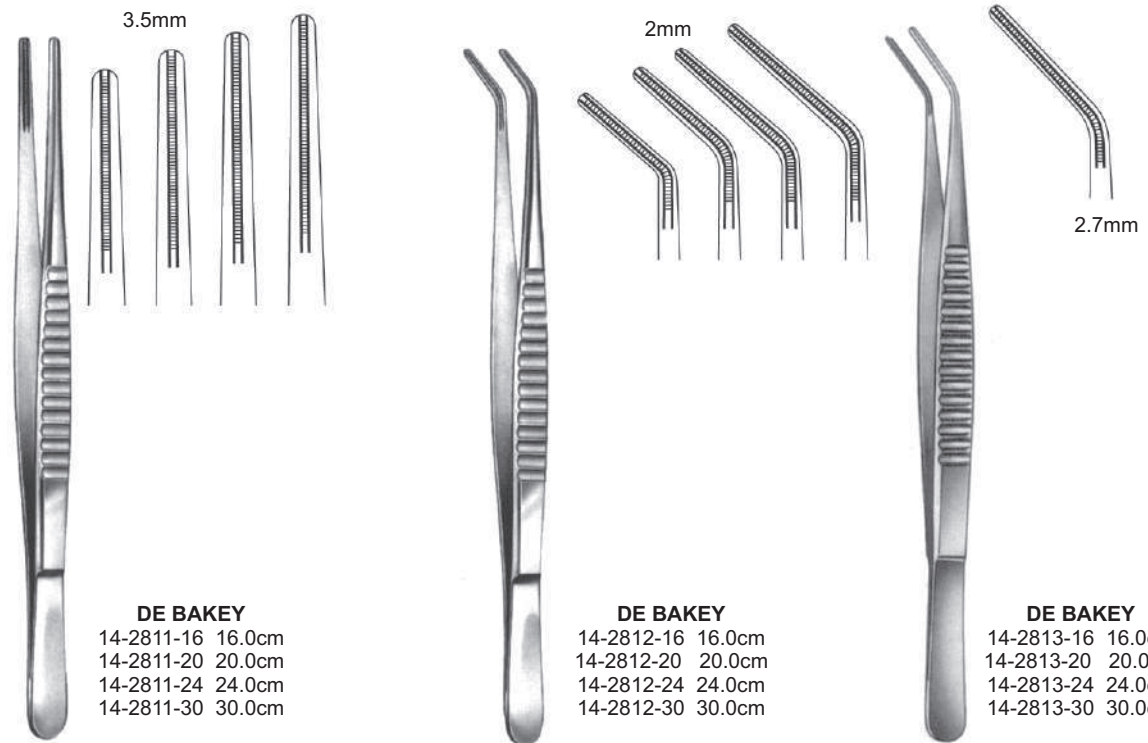

DE BAKEY
 14-2811-16 16.0cm
 14-2811-20 20.0cm
 14-2811-24 24.0cm
 14-2811-30 30.0cm

DE BAKEY
 14-2812-16 16.0cm
 14-2812-20 20.0cm
 14-2812-24 24.0cm
 14-2812-30 30.0cm

DE BAKEY
 14-2813-16 16.0cm
 14-2813-20 20.0cm
 14-2813-24 24.0cm
 14-2813-30 30.0cm

15

**Neurosurgery
Neurochirurgie
Neuro Cirugía**

Page 335 to 365



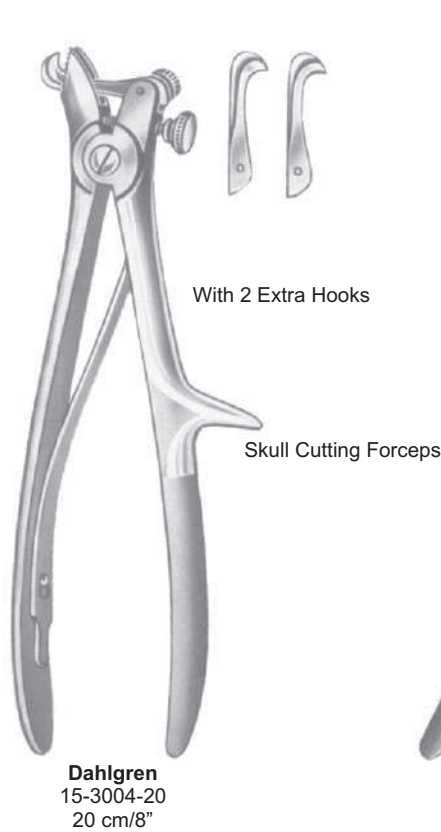
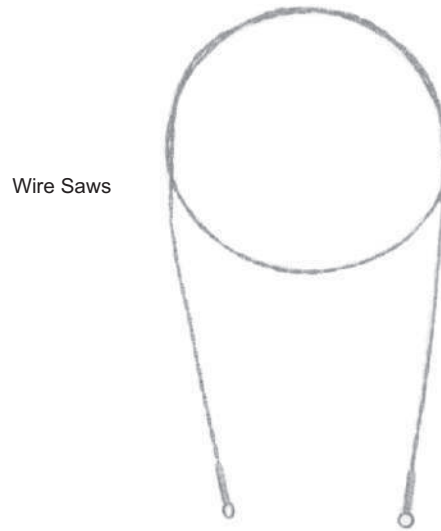

NEUROSURGERY

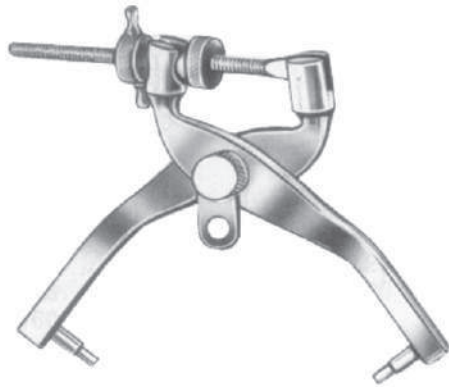

Crutchfield
15-3006-00



Crutchfield
15-3007-00



15-3008-00



Crutchfield
15-3009-00
Complete With 2 Drills

Instruments for Professionals

16

Ophthalmology
Ophthalmologie
Oftalmología

Page 366 to 396



OPHTHALMOLOGY



Weiss
 Children 16-3201-07
 7 cm/2¾"
 Adults 16-3202-09
 9 cm/3½"



Weiss
 Children 16-3203-07
 7 cm/2¾"
 Adults 16-3204-09
 9 cm/3½"



Park
 16-3205-08
 8 cm/3¼"



Park-Guyton
 16-3206-08
 8 cm/3¼"



Park-Maumenee
 16-3207-08
 8 cm/3¼"



Barraquer (Colibri)
 Children 16-3208-03
 3 cm/1¼"
 Adults 16-3209-04
 4 cm/1½"



Barraquer
 16-3210-04
 4 cm/1½"



Bowman
 16-3211-07
 7 cm/2¾"



Sauer
 16-3212-03
 3 cm/1¼"



Goldstein
 16-3213-03
 3 cm/1¼"



Pley
 16-3214-06
 6 cm/2¼"

For left eye

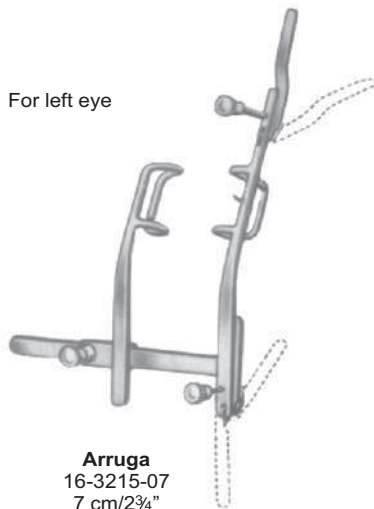

Arruga
 16-3215-07
 7 cm/2¾"

For right eye

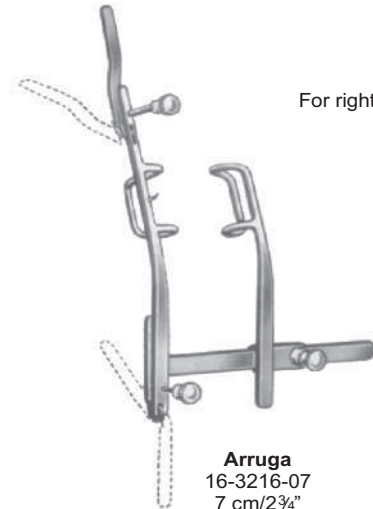

Arruga
 16-3216-07
 7 cm/2¾"

OPHTHALMOLOGY



Mellinger-Axenfeld
 16-3217-07
 7 cm/2 3/4"



Mellinger-Axenfeld
 16-3218-07
 7 cm/2 3/4"



Mellinger
 Children 16-3219-05
 5 cm/2 3/4"
 Adults 16-3220-07
 7 cm/2 3/4"



Mellinger Beard
 Children 16-3221-05
 5 cm/2"
 Adults 16-3222-07
 7 cm/2 3/4"



Knapp Clark
 16-3223-08
 8 cm/3 1/4"



Graefe
 Children 16-3224-06
 6 cm/2 1/2"
 Adults 16-3225-09
 9 cm/3 1/2"



Lancaster
 16-3226-08
 8 cm/3 1/4"



Williams
 Children 16-3227-07
 7 cm/2 3/4"
 Adults 16-3228-08
 8 cm/3 1/4"



Lister-Burch
 16-3229-08
 8 cm/3 1/4"



Weiss
 16-3230-08
 8 cm/3 1/4"



Murdock
 16-3231-05
 5 cm/2"



Mueller
 16-3232-07
 7 cm/2 3/4"



Critchett
 16-3233-06
 6 cm/2 1/2"



Castroviejo
 16-3234-08
 8 cm/3 1/4"

Instruments for Professionals

17

Otology

Otologie

Otología

Page 397 to 414



OTOLOGY INSTRUMENTS

Ø=Inside Dia



Troltsch
For Babies

- 17-3501-01 1.5 mm Ø
- 17-3501-02 2.5 mm Ø
- 17-3501-03 3.5 mm Ø

17-3501-30
Set of 3



Troltsch
For Adults

- 17-3502-04 4.0 mm Ø
- 17-3502-05 5.0 mm Ø
- 17-3502-06 6.0 mm Ø
- 17-3502-07 7.0 mm Ø

17-3502-30 17-3502-40
Set of 3 Set of 4



Poltzer

- 17-3503-01 2.0 mm Ø
- 17-3503-02 3.0 mm Ø
- 17-3503-03 4.0 mm Ø

17-3503-30
Set of 3



Erhard
For Adults

- 17-3504-01 3.0 mm Ø
- 17-3504-02 4.0 mm Ø
- 17-3504-03 5.0 mm Ø
- 17-3504-04 6.0 mm Ø

17-3504-30 17-3504-40
Set of 3 Set of 4



Hartmann
For Babies

17-3505-01 2.0 mm Ø



Hartmann
For Children

- 17-3506-02 3.0 mm Ø
- 17-3506-03 4.0 mm Ø
- 17-3506-04 5.5 mm Ø

17-3506-30
Set of 3



Hartmann
For Adults

- 17-3507-03 4.0 mm Ø
- 17-3507-04 5.5 mm Ø
- 17-3507-05 6.5 mm Ø
- 17-3507-06 7.5 mm Ø

17-3507-30 17-3507-40
Set of 3 Set of 4



Toynbee
For Adults

- 17-3508-01 4.5 mm Ø
- 17-3508-02 5.5 mm Ø
- 17-3508-03 6.5 mm Ø
- 17-3508-04 7.5 mm Ø

17-3508-30 17-3508-40
Set of 3 Set of 4

Alu Black



Gruber
Set of 6

Ø=Inside Dia

- 17-3509-01 4.5 x 5.5 mm Ø
- 17-3509-02 5.5 x 6.5 mm Ø
- 17-3509-03 6.5 x 7.5 mm Ø
- 17-3509-04 7.5 x 8.5 mm Ø
- 17-3509-05 8.5 x 9.5 mm Ø
- 17-3509-06 9.5 x 10.5 mm Ø



Gruber

17-3510-30 17-3510-40 17-3511-40 17-3511-40
Set of 3 Set of 4 Set of 3 Set of 4

- | | | | |
|---|----------------------|---|----------------------|
| ○ | 17-3510-01
3 mm Ø | ○ | 17-3511-01
3 mm Ø |
| ○ | 17-3510-02
4 mm Ø | ○ | 17-3511-02
4 mm Ø |
| ○ | 17-3510-03
5 mm Ø | ○ | 17-3511-03
5 mm Ø |
| ○ | 17-3510-04
6 mm Ø | ○ | 17-3511-04
6 mm Ø |

OTOLOGY INSTRUMENTS

Black



Hartmann
17-3512-40
Set of 4

- 17-3512-01 3.0 mm Ø
- 17-3512-02 4.0 mm Ø
- 17-3512-03 5.0 mm Ø
- 17-3512-04 7.0 mm Ø

Black



Hartmann
17-3513-20
Set of 2

- 17-3513-05 9.0 mm Ø
- 17-3513-06 11.0 mm Ø



17-3514-01



17-3514-02

- 17-3514-01 4.2 x 3.8 mm
- 17-3514-02 5.5 x 3.8 mm
- 17-3514-03 6.5 x 3.8 mm
- 17-3514-30 Set of 3



17-3514-03



17-3515-01



17-3515-02



17-3515-03

- 17-3515-01 4.2 mm
- 17-3515-02 5.5 mm
- 17-3515-03 6.5 mm
- 17-3515-30 Set of 3

- 17-3516-03 3.5 mm Ø
- 17-3516-04 4.5 mm Ø
- 17-3516-05 5.5 mm Ø
- 17-3516-06 6.5 mm Ø

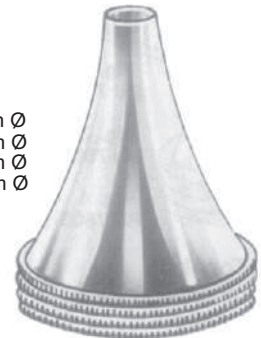

Bouillon
17-3516-40
Set of 4



Turmakin Speculum
Black finish (slot)

A= Distal tip diameter
 B= Distal slot width
 C= Proximal slot width

- 17-3517-01 No. 1 A=3mm B=2.5mm C=4mm
- 17-3517-02 No. 2 A=4.5mm B=3mm C=5mm
- 17-3517-03 No. 3 A=6.5mm B=3mm C=5mm
- 17-3517-04 No. 4 A=7mm B=3mm C=5mm
- 17-3517-05 No. 5 A=7.5mm B=3.5mm C=7mm
- 17-3517-06 No. 6 A=8mm B=4mm C=8mm
- 17-3517-07 No. 7 A=8.5mm B=4.5mm C=9mm
- 17-3517-08 No. 8 A=9mm B=5mm C=10mm
- 17-3517-09 No. 9 A=11mm B=6mm C=11mm



Gruber Speculum

- Black finish (round)
- 17-3518-03 3mm
- 17-3518-04 4mm
- 17-3518-05 5mm
- 17-3518-06 6mm

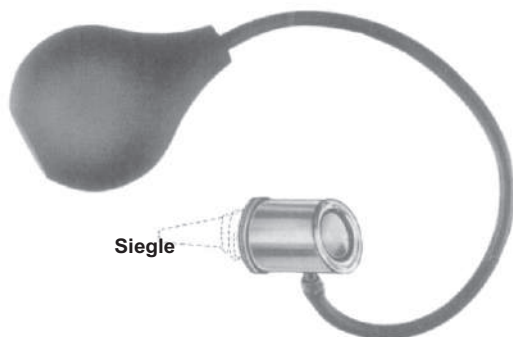

Siegler



Otoscope with 3 ear specula and rubber tube with bulb
17-3519-00

18

Rhinology
Rhinologie
Rinología

Page 415 to 439





Fraenkel
 18-3701-01 Fig. 1
 18-3701-02 Fig. 2
 18-3701-03 Fig. 3



18-3702-01
 18-3702-02
 18-3702-03
 13 cm/5"



Fig. 1
 18-3703-01
 18-3703-01

Fig. 2
 18-3704-02
 18-3704-02

Fig. 3
 18-3705-03
 18-3705-03



18-3706-01
 18-3706-02
 18-3706-03
 13 cm/5"



Hartmann
 15 cm/6"

18-3707-01

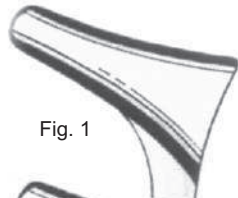

Fig. 1

18-3708-01

18-3707-02



Fig. 2

18-3708-02

18-3707-03

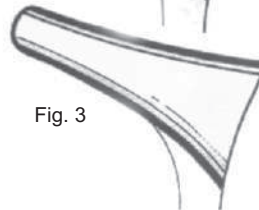

Fig. 3

18-3708-03



Hartmann
 15 cm/6"

RHINOLOGY INSTRUMENTS



18-3709-01

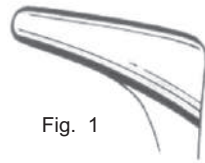

Fig. 1

18-3709-02

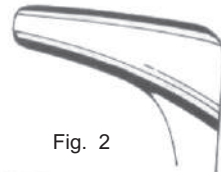

Fig. 2

18-3709-03

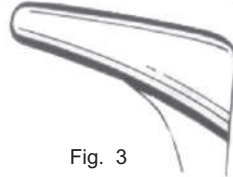

Fig. 3

Hartmann-Halle
15 cm/6"



18-3710-01

18-3710-02

18-3710-03

Hartmann-Halle
15 cm/6"



18-3711-01

18-3711-02

Tieck
13.5 cm/5 1/4"



18-3712-01

18-3712-02



Tieck
13.5 cm/5 1/4"



Beckmann
15 cm/6"



Fig. 1
18-3713-01

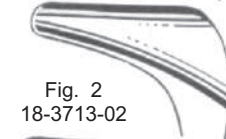

Fig. 2
18-3713-02



Fig. 3
18-3713-03

19

**Oral Instruments
Mund instrumente
Cirugía oral**

Page 440 to 444



Gag Only
19-3951-10

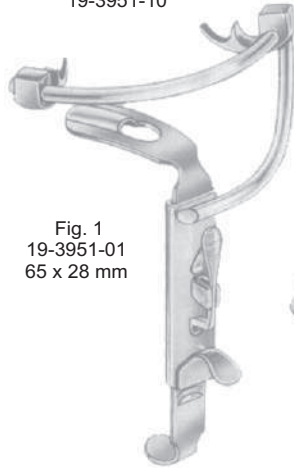

Fig. 1
19-3951-01
65 x 28 mm

Kilner-Doughty
Complete
19-3951-00

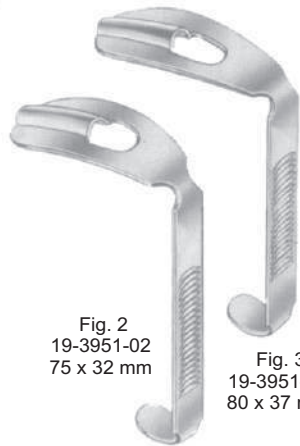

Fig. 2
19-3951-02
75 x 32 mm

Fig. 3
19-3951-03
80 x 37 mm

Gag Only
19-3952-10

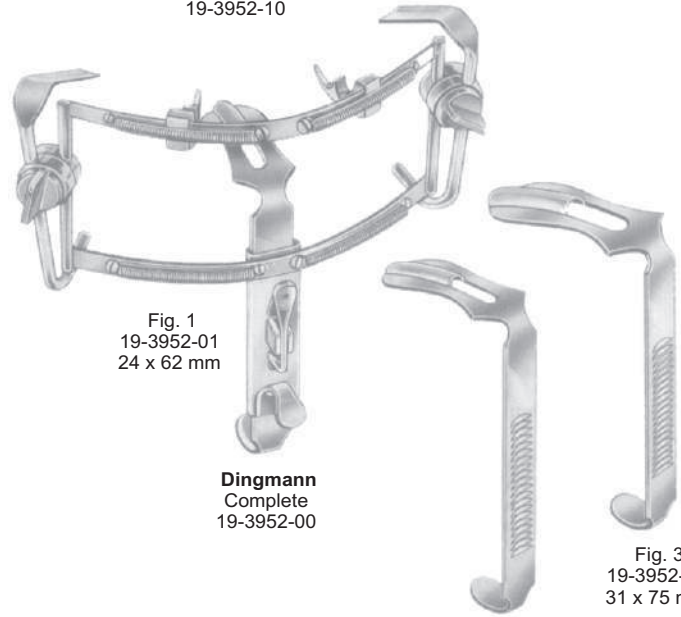

Fig. 1
19-3952-01
24 x 62 mm

Dingmann
Complete
19-3952-00

Fig. 2
19-3952-02
28 x 65 mm

Fig. 3
19-3952-03
31 x 75 mm

Gag Only
19-3953-10



Fig. 3
19-3953-03
24 x 80 mm

Davis-Boyle
Complete
19-3953-00

Fig. 5
19-3953-05
26 x 108 mm

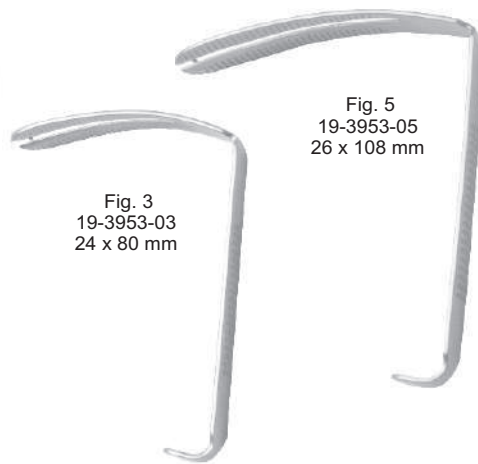

Gag Only
19-3954-10

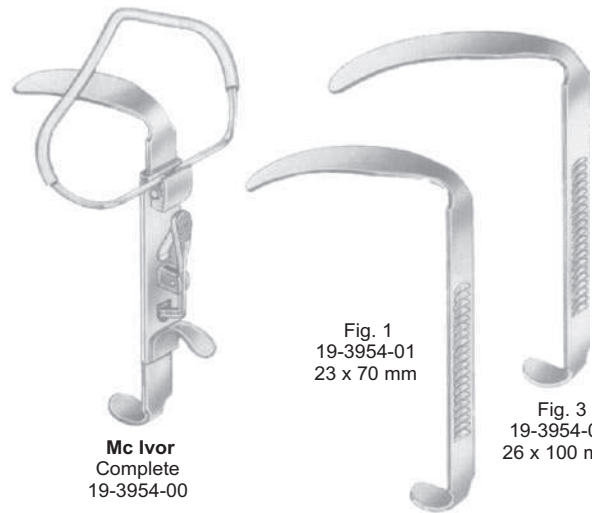

Fig. 1
19-3954-01
23 x 70 mm

Mc Ivor
Complete
19-3954-00

Fig. 2
19-3954-02
25 x 86 mm

Fig. 3
19-3954-03
26 x 100 mm

Fig. 1
19-3953-01
21 x 26 mm



Fig. 2
19-3953-02
23 x 65 mm



Fig. 4
19-3953-04
25 x 93 mm



ORAL INSTRUMENTS



Fig.	mm
2	19-3955-02 23 x 65
3	19-3955-03 24 x 80
4	19-3955-04 25 x 93
5	19-3955-05 26 x 108

Modell Wurzburg

Fig.	mm
1	19-3956-01 28 x 66
2	19-3956-02 32 x 75
3	19-3956-03 34 x 83
4	19-3956-04 37 x 93
5	19-3956-05 38 x 100



Chest Support for Mouth gag
19-3957-00



Mouth Gags

Baby-Molt
19-3958-10
10 cm/4"

Molt
19-3959-11 11 cm/4 1/4"
19-3959-14 14 cm/5 1/2"

Roser-Konig
19-3960-16 16 cm/6 1/4"
19-3960-19 19 cm/7 1/2"

Denhart
19-3961-12
12 cm/4 3/4"

Instruments for Professionals

20

**Tonsil
Mandel
Amígdala**

Page 445 to 451

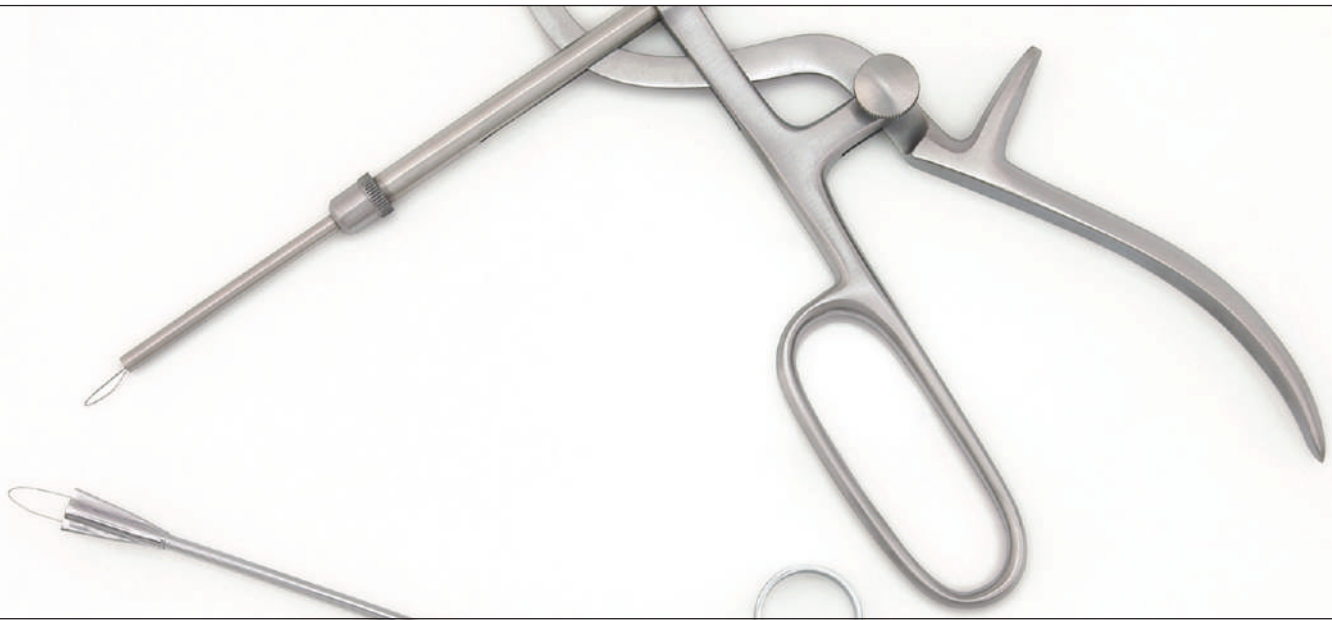

TONSIL



Luniatschek
 20-4051-18
 18 cm/7"



Luniatschek
 20-4052-18
 18 cm/7"

Gauze Packers



Trelat
 20-4053-23
 23 cm/9"



Claus
 20-4054-23
 23 cm/9"



Hurd
 20-4055-24
 24 cm/9½"



Hurd
 20-4056-21
 21 cm/8¼"



Nager
 20-4057-24
 24 cm/9½"



Falk
 20-4058-24
 24 cm/9½"



Falk
 20-4059-24
 24 cm/9½"



Claus-Eicken
 20-4060-23
 23 cm/9 "

Ligature Carrier



Roeder
 20-4061-26
 26 cm/10¼"

TONSIL

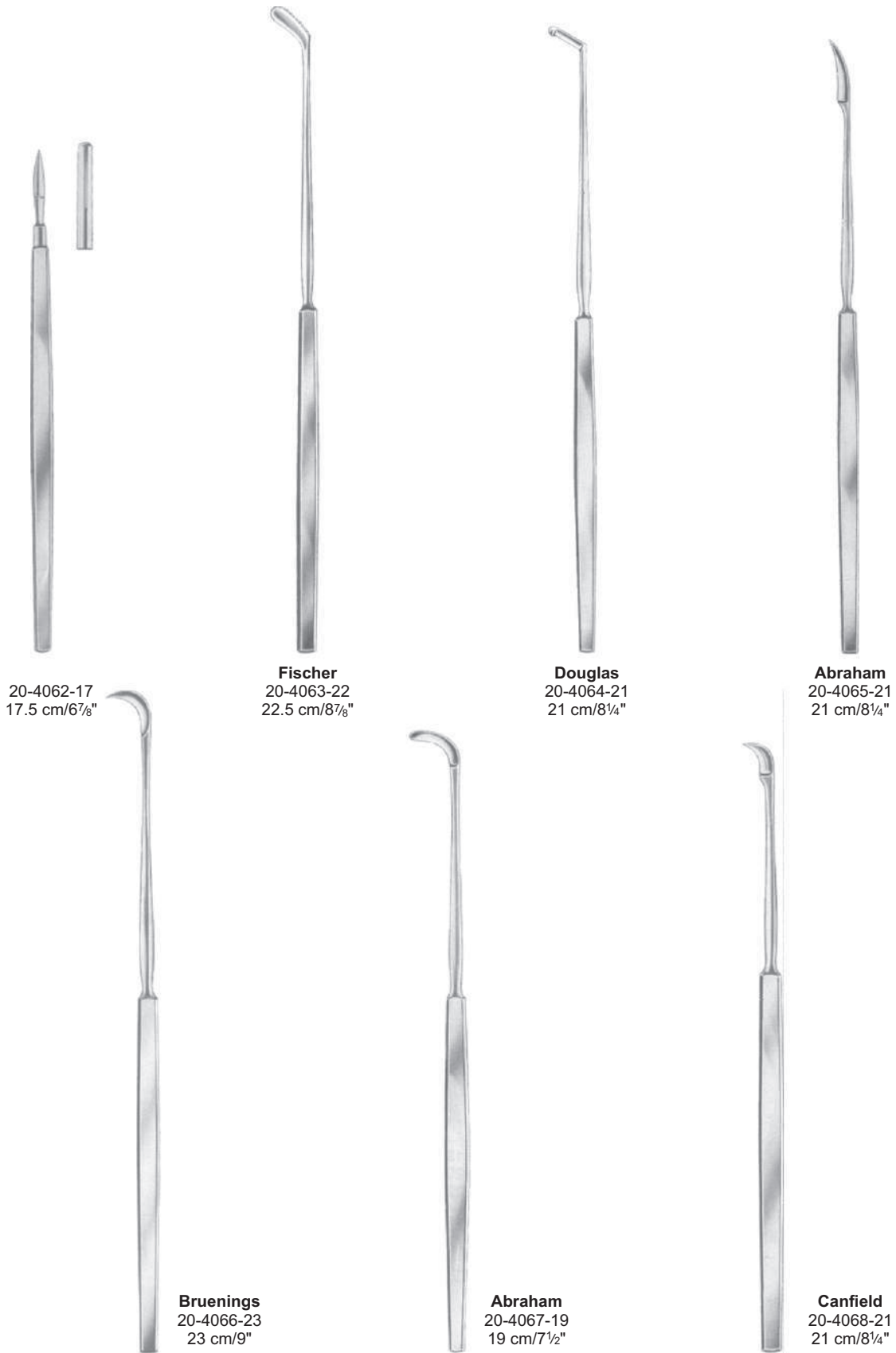

21

**Tracheotomy
Tracheotomie
Traqueotomía**

Page 452 to 456



TRACHEOTOMY

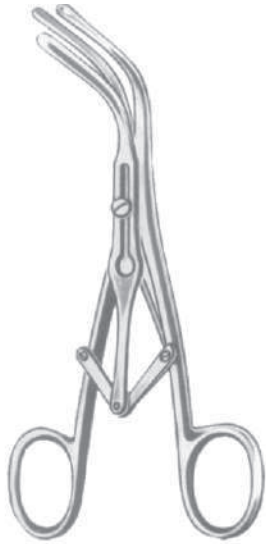

Laborde
 21-4151-13 13 cm/5"
 21-4151-15 15 cm/6"



Trousseau (Adult)
 21-4152-14
 14 cm/5½"



Trousseau (Child)
 21-4153-13
 13 cm/5"

Hooks

Left

Right



Sharp



Bose
 21-4154-07
 7 cm/2¾"



21-4155-16



21-4156-16

Bose
 16 cm/6¼"

Thyroid Gland Retractor



Trachea Trocars



Uckerman
 21-4158-08 08 mm Ø
 21-4158-10 10 mm Ø
 13 cm/5"

TRACHEOTOMY

International scale

Fig.	0	1	2	3	4	5	6	7	8	9
Diameter	④	⑤	⑥	⑦	⑧	⑨	⑩	⑪	⑫	⑬mm
Lenght of outer tube N	45	50	55	60	65	70	75	80	85	90mm



LUER

Fig	mmØ	45-90mm	95mm	105mm
0	4	21-4159-04		
1	5	21-4159-05		
2	6	21-4159-06		
3	7	21-4159-07		
4	8	21-4159-08	21-4160-08	21-4161-08
5	9	21-4159-09	21-4160-09	21-4161-09
6	10	21-4159-10	21-4160-10	21-4161-10
7	11	21-4159-11	21-4160-11	21-4161-11
8	12	21-4159-12	21-4160-12	21-4161-12
9	13	21-4159-13	21-4160-13	21-4161-13



CHEVALIER-JACKSON

Fig	mmØ	45-90mm
0	4	21-4162-04
1	5	21-4162-05
2	6	21-4162-06
3	7	21-4162-07
4	8	21-4162-08
5	9	21-4162-09
6	10	21-4162-10
7	11	21-4162-11
8	12	21-4162-12
9	13	21-4162-13

22

**Goitre
Kropfchirurgie
Bocio**

Page 457



GOITRE INSTRUMENTS

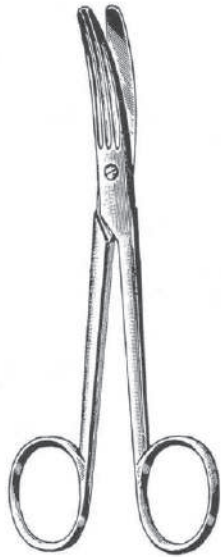

SCHOEMAKER
 22-4201-15 15.0cm

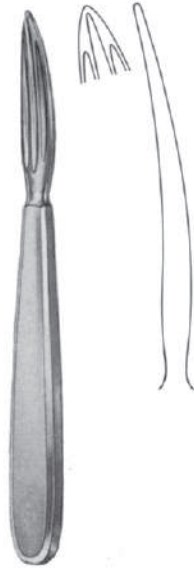

KOCHER
 22-4202-15 15.0cm
 22-4202-16 16.0cm

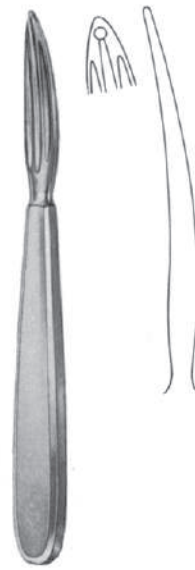

KOCHER
 22-4203-15
 22-4203-16



KOCHER
 22-4204-18 18.0cm



HOFMEISTER
 22-4205-21 21.0cm



LAHEY
 22-4206-15 15.0cm
 22-4206-20 20.0cm



MASTIN
 22-4207-17 17.0cm

23

Dermatology

Dermatologie

Dermatología

Page 458 to 459



Comedone Extractors



Schamberg
 23-4251-10
 10 cm/4"



Unna
 23-4252-14
 14 cm/5½"



Unna
 23-4253-14
 14 cm/5½"



Sealfield
 23-4254-10
 10 cm/4"



Saalfeld
 23-4255-14
 14 cm/5½"



Katsch
 23-4256-14
 14 cm/5½"



Hebra
 23-4257-18
 18 cm/7"

Skin Currettes



Piffard
 14.5cm/5¾"



Fig. 1 23-4258-01



Fig. 2 23-4258-02



Fig. 3 23-4258-03

DERMATOLGOY

Lupus Currettes

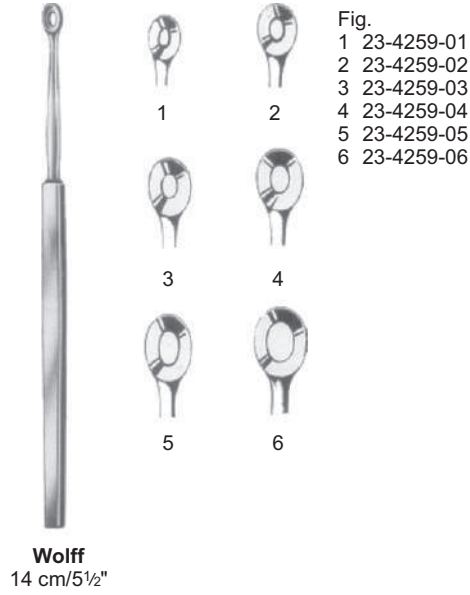

Lupus Currettes

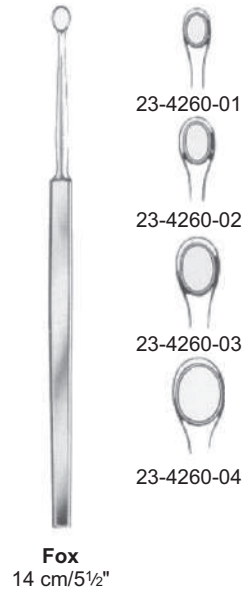

Lupus Scraper



Moncorps Knife



Gillies
 Fig. 1 23-4263-01
 Fig. 2 23-4263-02
 18 cm/7"

Cutaneous Hook



24

**Stomach, Intestine, Rectum
Magen, Darm, Mastdarm
Estómago, Intestinos, Recto**

Page 460 to 481



STOMACH, INTESTINE, RECTUM



Allis

cm	in	4 : 5	5 : 6
15	6"	24-4301-15	24-4302-15
19	7½"		24-4302-19
23	9"		24-4302-23
25	10"		24-4302-25



Baby-Allis

24-4303-12	12 cm/4¾"
24-4303-14	14 cm/5½"



Allis-Atrauma

24-4304-16	16 cm/6¼"
24-4304-20	20 cm/8"
24-4304-25	25 cm/10"
24-4304-30	30 cm/12"



Allis-Adair
 24-4305-15
 15 cm/6"



Baby-Allis
 24-4306-15
 15 cm/6"



Lockwood-Allis
 24-4307-16 16 cm/6¼"
 24-4307-20 20 cm/8"



Thoms-Allis
 24-4308-20
 20 cm/8"

STOMACH, INTESTINE, RECTUM

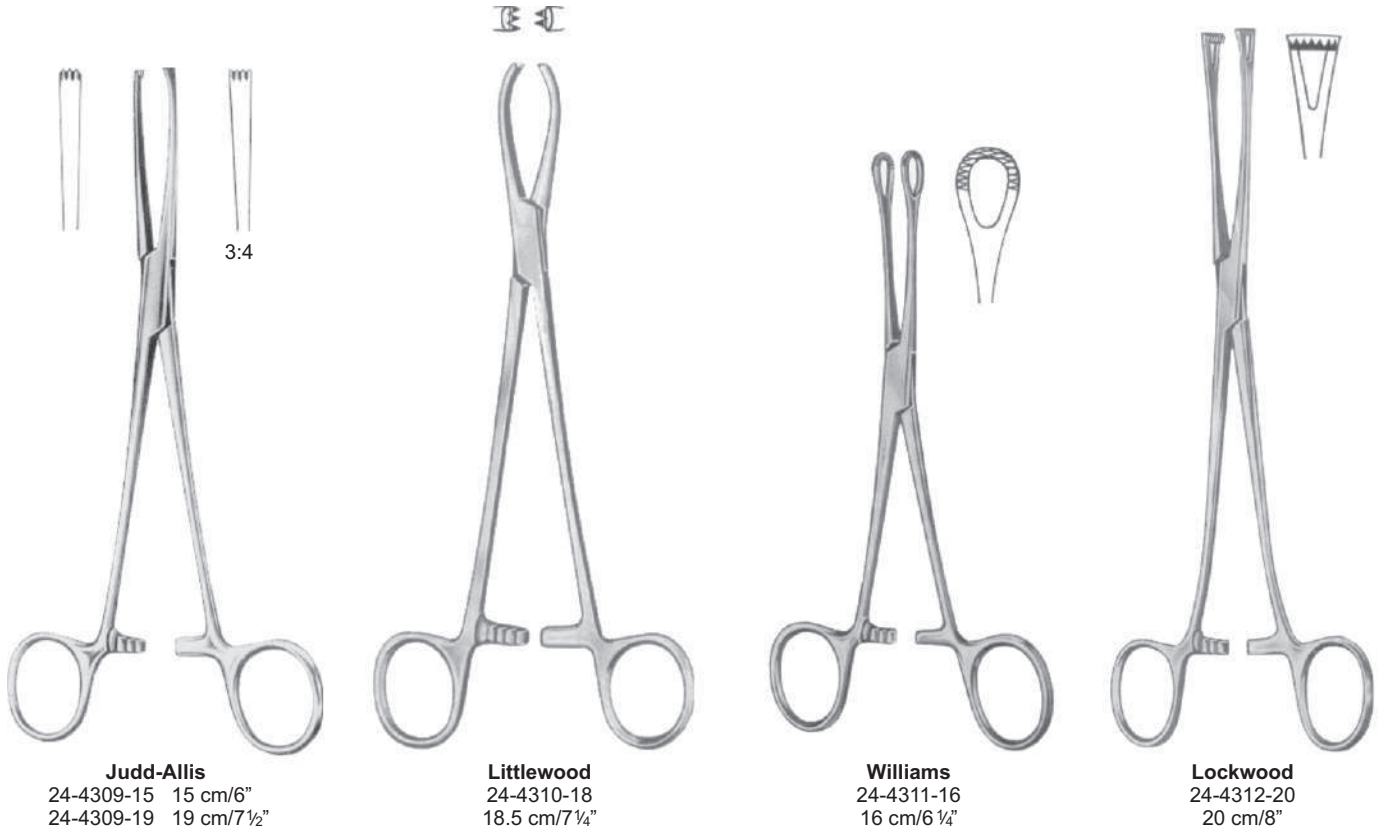

Atrauma

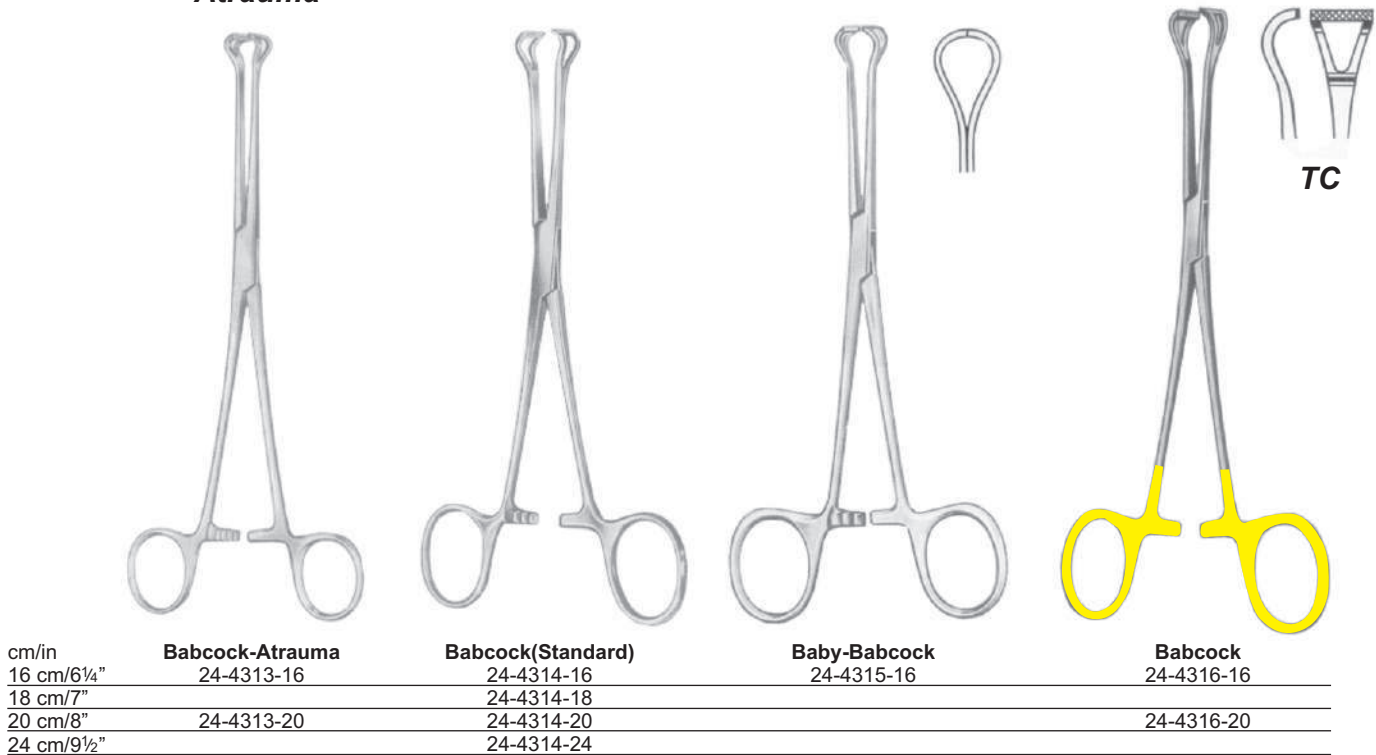

Instruments for Professionals

25

Kidney, Liver, Gall Stone, Urology

Niere, Leber, Galle, Urologie

Riñón, Hígado, Bilis, Urología

Page 482 to 495



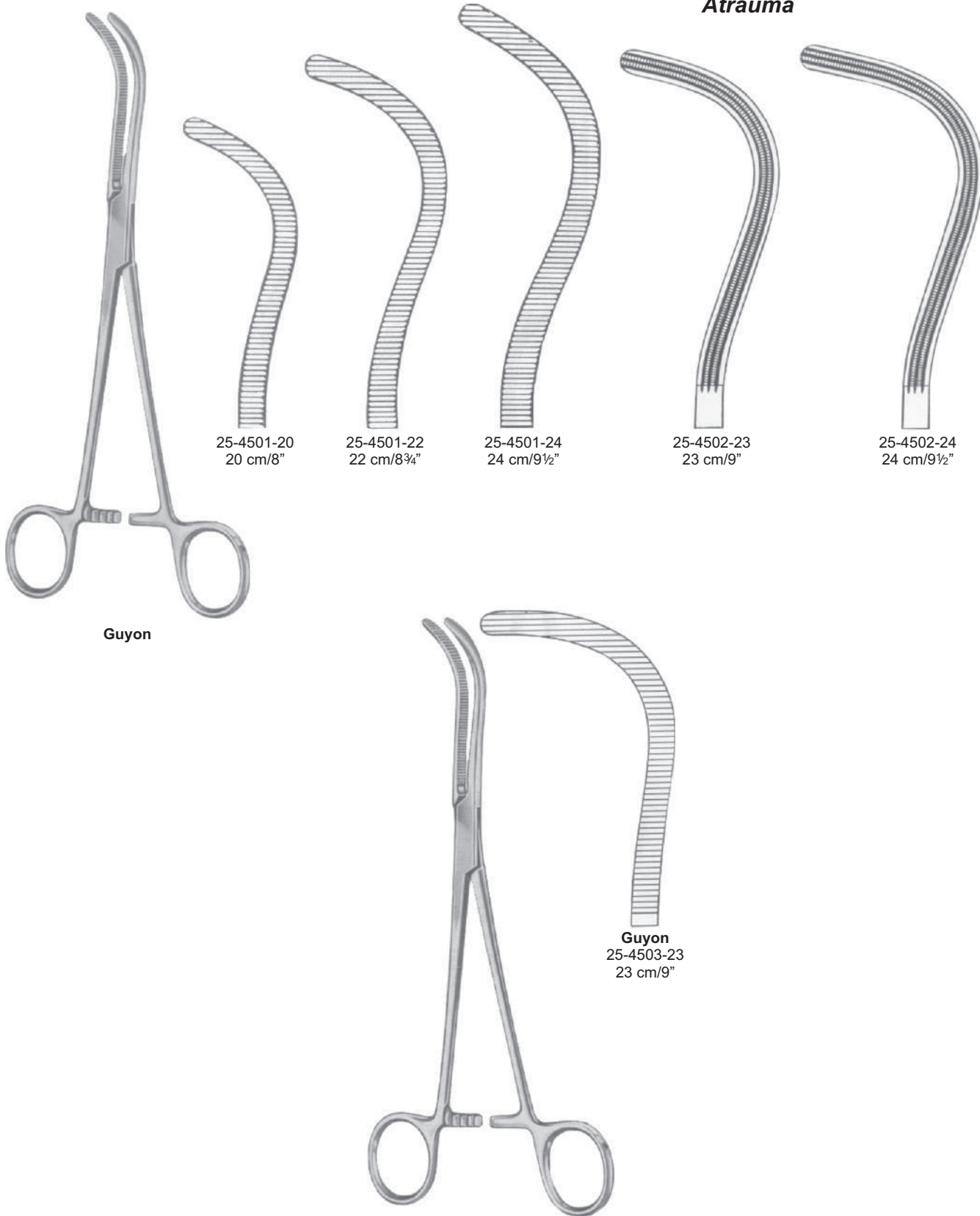

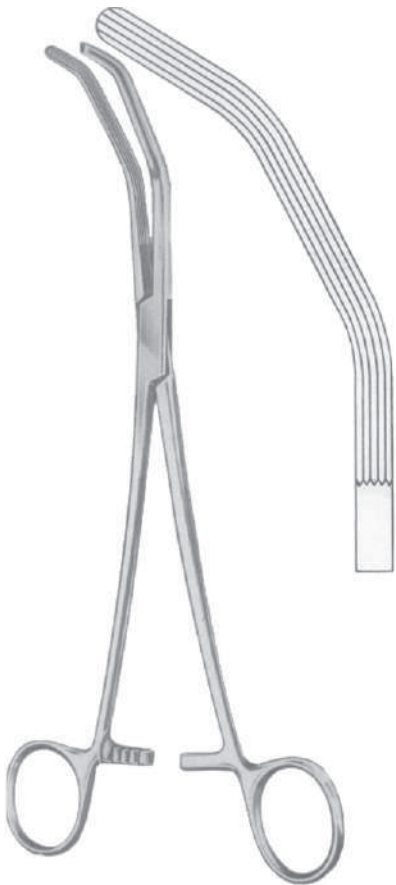

Herrick
 25-4504-23
 23 cm/9"



Mayo-Guyon
 25-4505-23
 23 cm/9"



Stille
 25-4506-23
 23 cm/9"

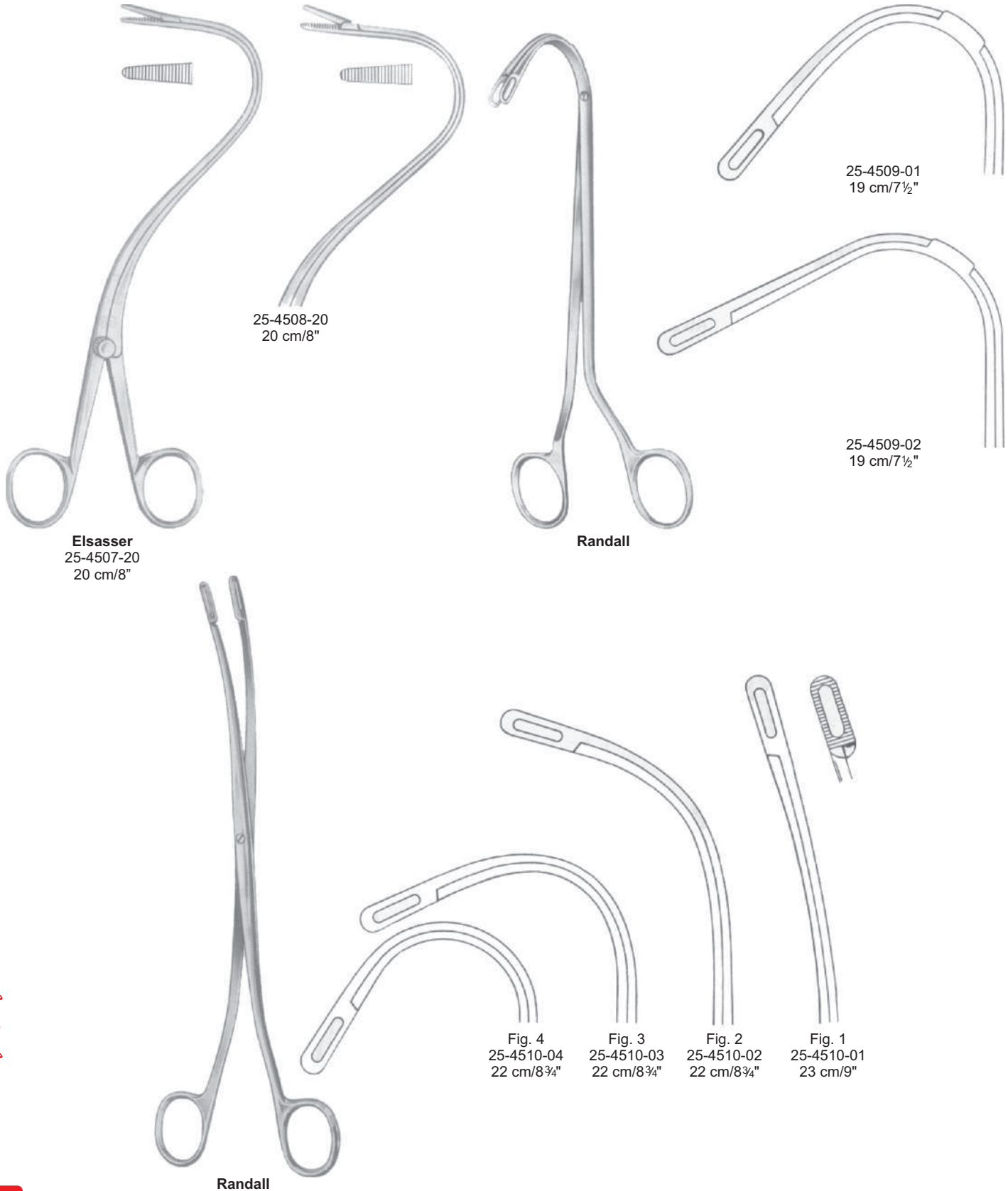

Instruments for Professionals

26

Gynecology
Gynäkologie
Ginecología

Page 496 to 535



Scheme of Dimensions for Specula

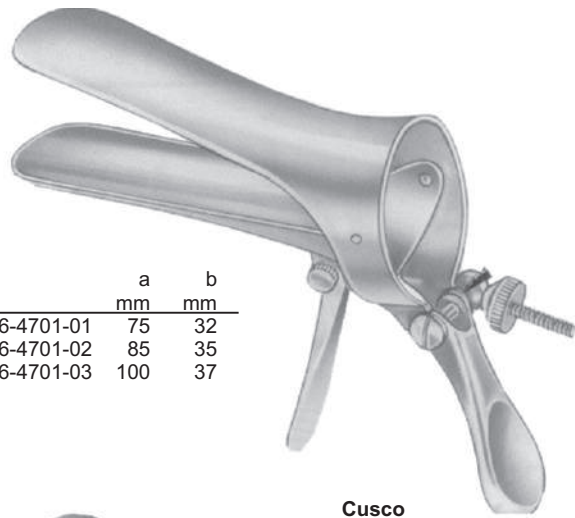
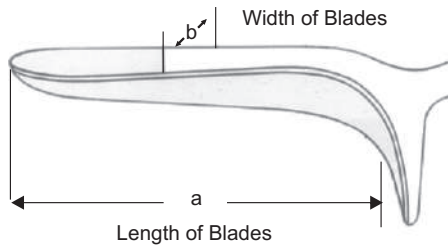

	a mm	b mm
26-4701-01	75	32
26-4701-02	85	35
26-4701-03	100	37

Cusco

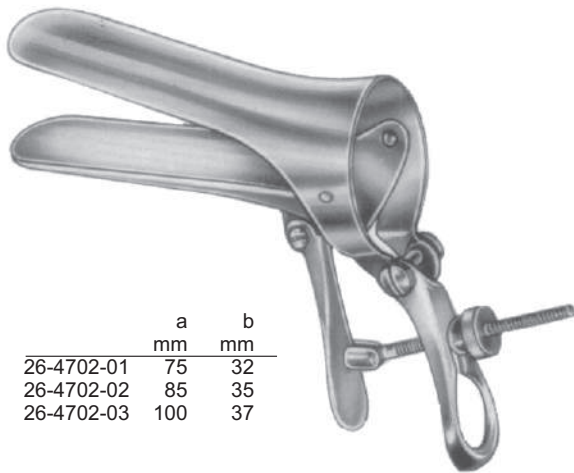

	a mm	b mm
26-4702-01	75	32
26-4702-02	85	35
26-4702-03	100	37

Cusco



For Virgins	a mm	b mm
26-4703-00	75	17

Cusco

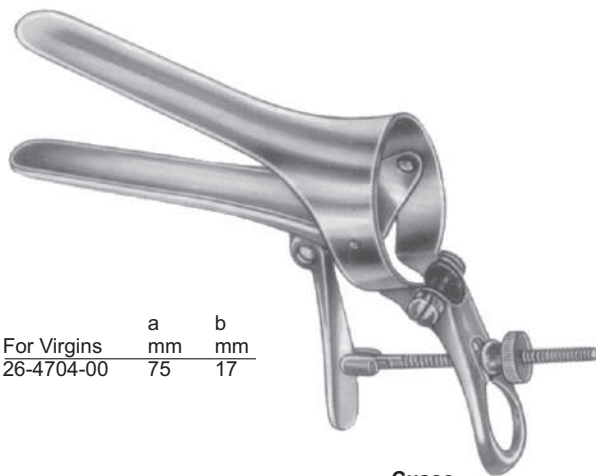

For Virgins	a mm	b mm
26-4704-00	75	17

Cusco

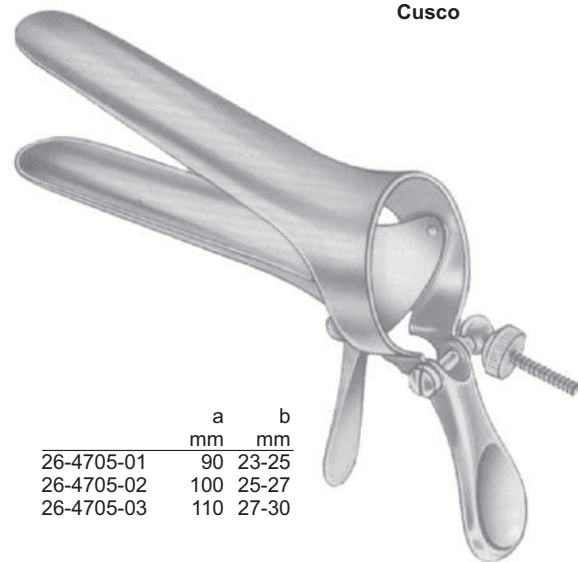

	a mm	b mm
26-4705-01	90	23-25
26-4705-02	100	25-27
26-4705-03	110	27-30

Cusco
Swiss Pattern

GYNECOLOGY

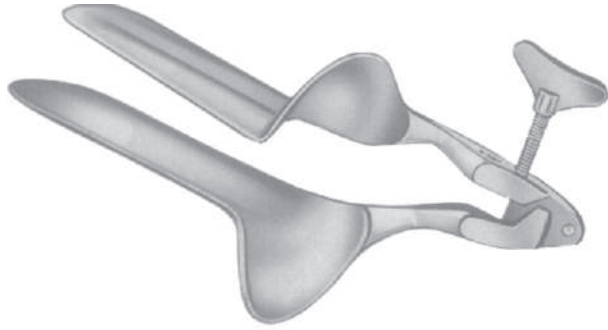

Collin-Landau

Small	26-4706-01	30 x 85 mm
Medium	26-4706-02	35 x 100 mm
Large	26-4706-03	40 x 110 mm



Collin

Small	26-4707-01	30 x 85 mm
Medium	26-4707-02	35 x 100 mm
Large	26-4707-03	40 x 110 mm

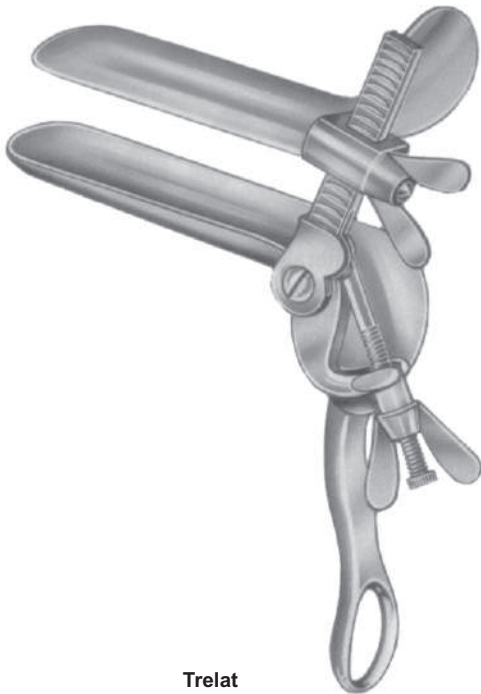

Trelat

	a mm	b mm
26-4708-01	85	33
26-4708-02	95	35
26-4708-03	115	43



Grave (Standard)

	a mm	b mm
26-4709-01	75	20
26-4709-02	95	30
26-4709-03	115	35
26-4709-04	125	35

Black



Grave	a mm	b mm
26-4710-01	75	20
26-4710-02	95	35
26-4710-03	115	35



Grave	a mm	b mm
Angled 135° 26-4711-00	101	35

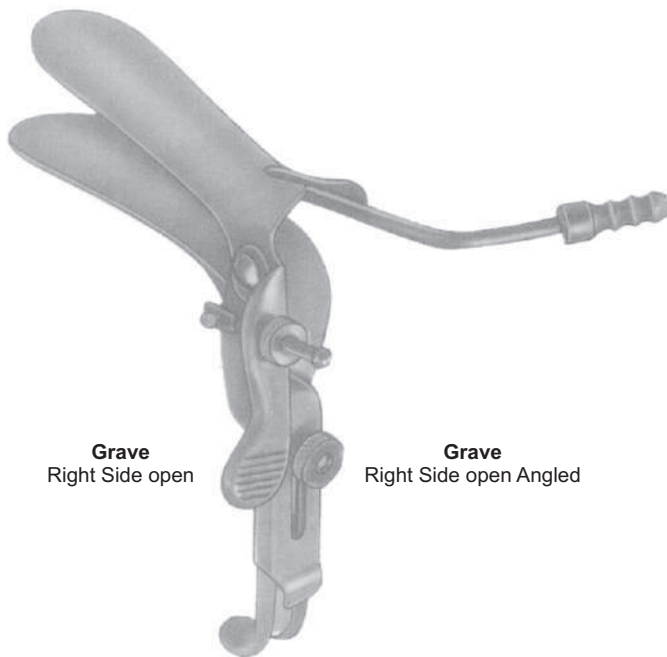

Grave
Right Side open

26-4712-01

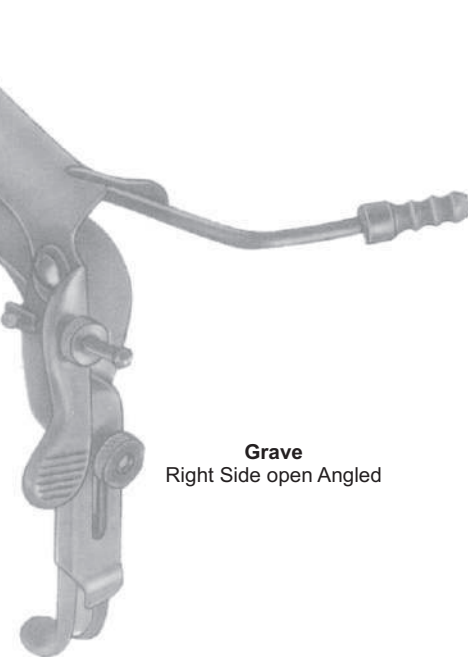

Grave
Right Side open Angled

26-4712-02

a mm	b mm
101	35

Lateral Specula



26-4713-00

27

Obstetrics
Geburtshilfe
Obstetricia

Page 536 to 542



For Internal Measurements



27-5001-45
 Laparotomy Ring
 1¾" Inside Diameter



De Lee
 27-5002-20
 20 cm/8"
 cm/Inch Scale



Martin
 27-5003-34 34 cm/13½" 27-5004-34
 cm Scale cm/Inch Scale



Collin
 27-5005-35
 35 cm/13¾"
 cm Scale



Breisky
 27-5006-33
 33 cm/13"
 cm Inch Scale



Collyer
 27-5007-30
 30 cm/12"
 cm Inch Scale



Iowa
 27-5008-14
 14 cm/5½"
 Trumpet Needle Guide

OBSTETRICS INSTRUMENTS



Winter
28 cm/11"

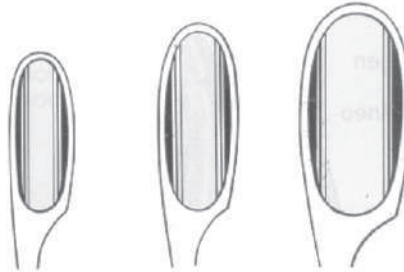

Straight	27-5009-01	27-5009-02	27-5009-03
Curved	27-5010-01	27-5010-02	27-5010-03



Wallich
27-5011-42
42 cm/16¾"



Sanger
21 cm/10½"

Straight
27-5012-27

Curved
27-5013-27

Uterine Haemostasis Forceps



Green-Armytage
27-5014-21
21 cm/8¼"

Instruments for Professionals

Scalp Flap Forceps



Gauss
 27-5015-26
 26 cm/10¼"



Willet-Martel
 27-5016-19
 19 cm/7½"

Head Lever



Murless
 27-5017-26
 26 cm/10¼"

Elevating Spoon



Sellheim
 27-5018-28
 28 cm/11"



Smellie
 27-5019-25
 25 cm/10"

Perforators



Nagele
 27-5020-25
 25 cm/10"

28

Sterilization
Sterilisation
Esterilización

Page 543 to 544





CHEATLE
 28-5101-27 27.0cm

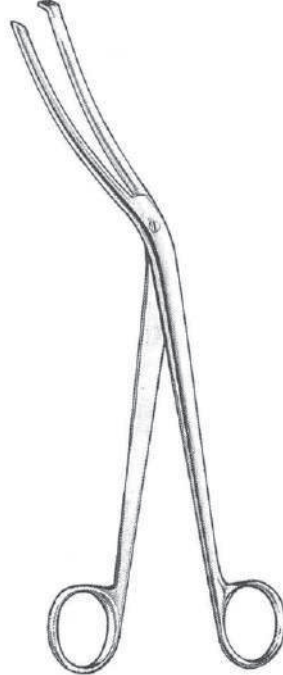

CHEATLE
 28-5102-27 26.5cm



CHEATLE
 28-5103-28 28.0cm



28-5104-20 20.0cm
 28-5104-30 30.0cm

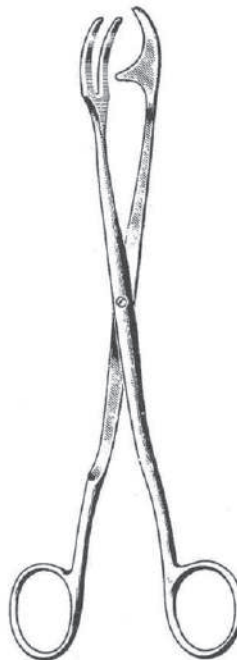

ROGGE
 28-5105-23 23.0cm



DAVIS
 28-5106-16 16.0cm
 28-5106-20 20.0cm
 28-5106-24 24.0cm

STERILIZATION

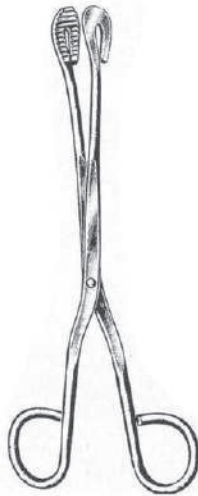

UNIVERSAL
 28-5107-20 20.0cm
 28-5107-28 28.0cm

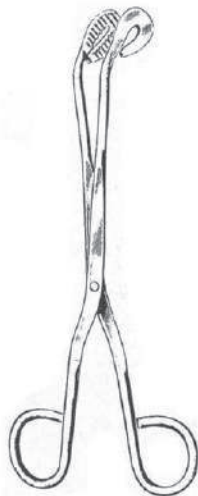

UNIVERSAL
 28-5108-20 20.0cm
 28-5108-28 28.0cm

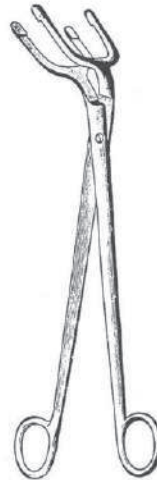

PYE-SMITH (HARRISON)
 28-5109-25 25.0cm
 28-5109-30 30.0cm

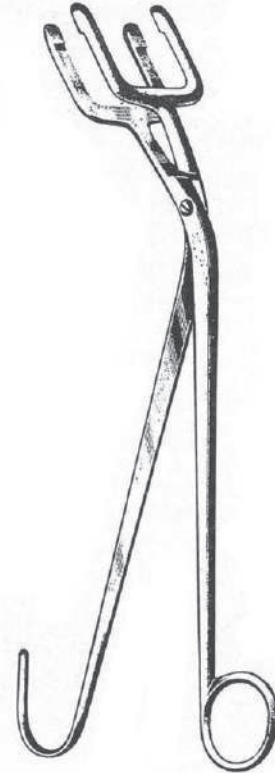

HARRISON
 28-5110-25 25.0cm
 28-5110-30 30.0cm
 28-5110-35 35.0cm
 28-5110-45 45.0cm

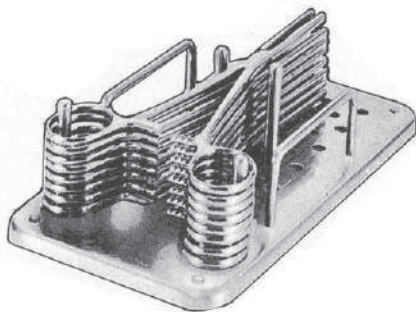

28-5111-00



BUNT
 28-5112-12 12.0cm

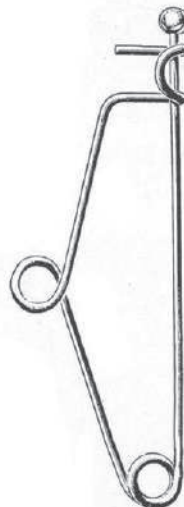

MAYO
 28-5113-10 10.0cm
 28-5113-12 12.0cm
 28-5113-14 14.0cm
 28-5113-15 15.0cm



MAYO
 28-5114-14 14.0cm

29

Asepsis

Asepsis

Asepsia

Page 545 to 546





cm	in	
11	4½"	29-5201-11
13	5	29-5201-13
14	5½"	29-5202-14
16	6¼"	29-5202-16

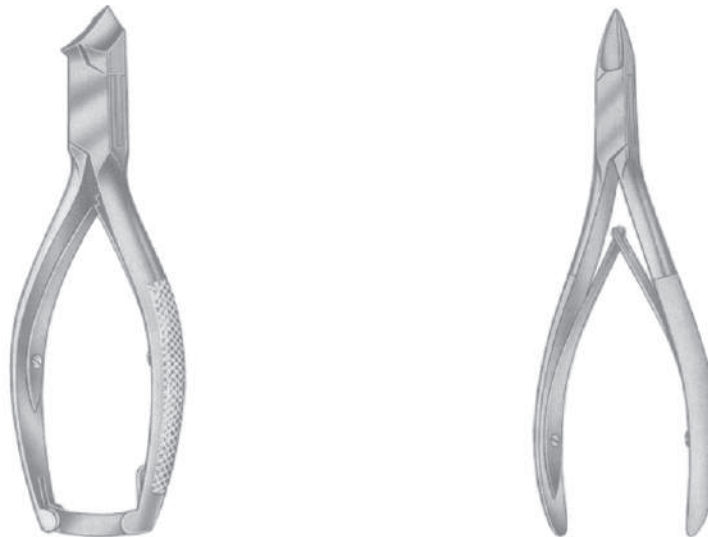

cm	in	
11	4½"	29-5204-11
13	5	29-5204-13
14	5½"	29-5203-14
15	6"	29-5203-15

ASEPSIS

Stainless

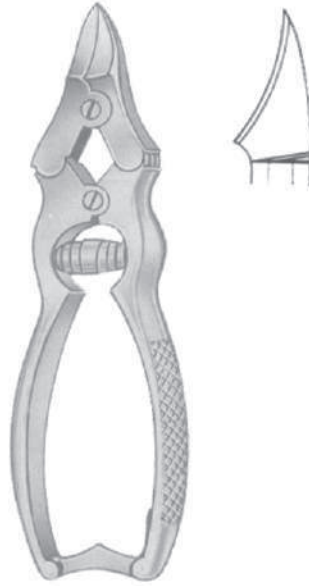

29-5205-15
15 cm/6"



29-5206-10
29-5206-10
10 cm/4"



Straight
Curved

29-5207-10
29-5207-10
10 cm/4"



29-5208-10
10 cm/4"



29-5209-11
11 cm/4½"
29-5209-13
13 cm/5"

30

**Hollowware
Hollowware
Hollowware**

Page 547 to 552



HOLLOWWARE



Needle Case Round with Cover
30-5301-01 65x15mm



Needle Case Round
30-5302-01 80x20mm



Needle Case Rectangle
30-5303-01 70x70x10mm

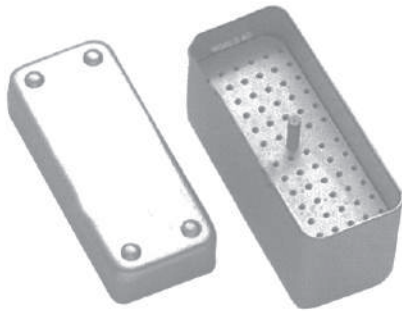

Endodontic Box
30-5304-01
100x40x50mm

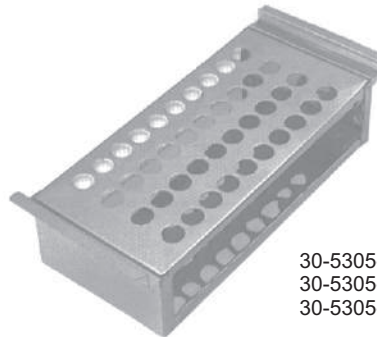

Tube Rack

30-5305-01 6.35x15.25x5cm for 12 tubes
 30-5305-02 6.35x17.75x7.5cm for 27 tubes
 30-5305-03 7.50x17.75x6.35cm for 36 tubes



Sprit Lamp
30-5306-01
Standard Size



Sprit Lamp
30-5307-01
Standard Size



Sputum Cup

30-5308-01 75x80mm
 30-5308-02 100x50mm
 30-5308-03 100x80mm



Dressing Jar

30-5309-01	80x60mm	30-5310-01
30-5309-02	80x80mm	30-5310-02
30-5309-03	100x100mm	30-5310-03
30-5309-04	120x120mm	30-5310-04
30-5309-05	150x150mm	30-5310-05
30-5309-06	180x180mm	30-5310-06
30-5309-07	200x200mm	30-5310-07



Dressing Jar



Fennle

30-5312-01 100mm Ø
 30-5312-02 120mm Ø
 30-5312-03 150mm Ø
 30-5312-04 200mm Ø



Cotton Holder
30-5311-01



Cotton Holder
30-5311A-01



HOLLOWWARE



Forceps Jar

- 30-5313-01 30x90mm
- 30-5313-02 50x125mm
- 30-5313-03 50x170mm
- 30-5313-04 50x200mm
- 30-5313-05 40x230mm
- 30-5313-06 70x110mm
- 30-5313-07 80x150mm
- 30-5313-08 100x200mm
- 30-5313-09 150x30mm



Medicine Cup

- 30-5316-01 50ml
- 30-5316-02 60ml
- 30-5316-03 70ml



Kick Bucket with Trolley

- 30-5319-01
- 390x280x180mm



Gallipot

- | | |
|------------------|------------------|
| 30-5314-01 01 oz | 30-5314-09 09 oz |
| 30-5314-02 02 oz | 30-5314-10 10 oz |
| 30-5314-03 03 oz | 30-5314-11 11 oz |
| 30-5314-04 04 oz | 30-5314-12 12 oz |
| 30-5314-05 05 oz | 30-5314-13 13 oz |
| 30-5314-06 06 oz | 30-5314-14 14 oz |
| 30-5314-07 07 oz | 30-5314-15 15 oz |
| 30-5314-08 08 oz | 30-5314-16 16 oz |



Sponge Bowl

- 30-5315-01 12 cm
- 30-5315-02 15 cm
- 30-5315-03 20 cm



Lotion Bowl without spout

- | | |
|---------------------|----------------------|
| 30-5317-01 40x19mm | 30-5317-08 150x65mm |
| 30-5317-02 50x25mm | 30-5317-09 180x85mm |
| 30-5317-03 60x30mm | 30-5317-10 200x100mm |
| 30-5317-04 80x40mm | 30-5317-11 250x120mm |
| 30-5317-05 100x50mm | 30-5317-12 300mm |
| 30-5317-06 120x60mm | 30-5317-13 350mm |
| 30-5317-07 140x60mm | 30-5317-14 400mm |



Wash Basin

- 30-5318-01 300x80mm
- 30-5318-02 320x85mm
- 30-5318-03 330x90mm
- 30-5318-04 350x110mm
- 30-5318-05 400x115mm



Kidney Tray

- 30-5321-01 12cm
- 30-5321-02 15cm
- 30-5321-03 18cm
- 30-5321-04 20cm
- 30-5321-05 25cm
- 30-5321-06 28cm
- 30-5321-07 30cm



Kidney Tray Shallow

- 30-5320-01 17cm
- 30-5320-02 22cm
- 30-5320-03 24cm



Kidney Tray (with cover)

- 30-5322-01 15cm
- 30-5322-02 20cm
- 30-5322-03 25cm
- 30-5322-04 30cm

Instruments for Professionals

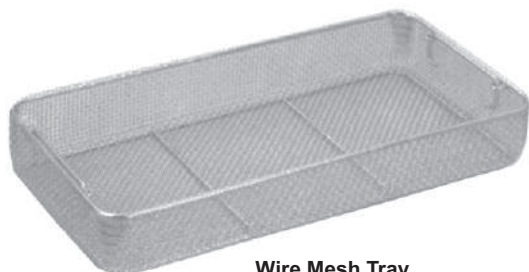

Wire Mesh Tray

- 30-5323-01 240x250x5mm
- 30-5323-02 480x250x5mm
- 30-5323-03 550x250x5mm
- 30-5323-04 240x250x7mm
- 30-5323-05 480x250x7mm
- 30-5323-06 240x250x10mm
- 30-5323-07 480x250x10mm

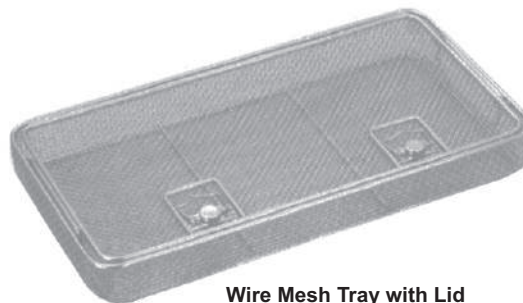

Wire Mesh Tray with Lid

- 30-5324-01 240x250x5mm
- 30-5324-02 480x250x5mm
- 30-5324-03 550x250x5mm
- 30-5324-04 240x250x7mm
- 30-5324-05 480x250x7mm
- 30-5324-06 240x250x10mm
- 30-5324-07 480x250x10mm



Perforated Tray

- 30-5325-01 200x100x40mm
- 30-5325-02 250x120x50mm
- 30-5325-03 300x150x50mm
- 30-5325-04 350x170x50mm
- 30-5325-05 400x200x50mm



Instruments Tray without Lid

- 30-5326-01 100x150x25mm
- 30-5326-02 150x200x40mm
- 30-5326-03 200x250x45mm
- 30-5326-04 250x300x50mm
- 30-5326-05 300x350x50mm
- 30-5326-06 150x300x50mm
- 30-5326-07 200x300x50mm
- 30-5326-08 230x150x50mm



Instruments Tray with Lid

- 30-5327-01 100x150x25mm
- 30-5327-02 150x200x40mm
- 30-5327-03 200x250x45mm
- 30-5327-04 250x300x50mm
- 30-5327-05 300x350x50mm
- 30-5327-06 150x300x50mm
- 30-5327-07 200x300x50mm
- 30-5327-08 230x150x50mm



Burr Tray

- 30-5328-01
190x100x20mm

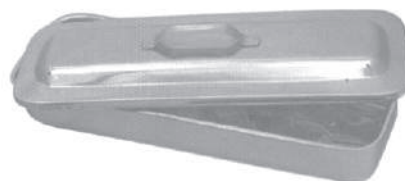

Cathetes Tray with Lid

- 30-5329-01 300x80x40mm
- 30-5329-02 350x90x45mm
- 30-5329-03 400x100x50mm

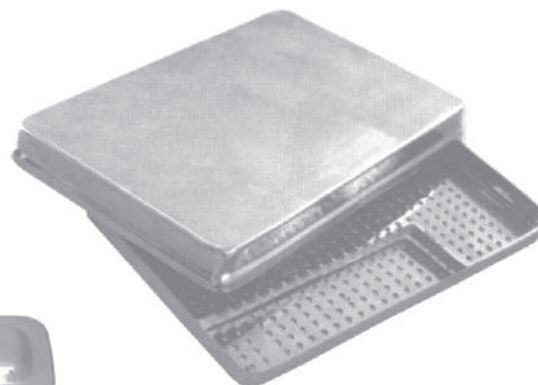

Scaler Tray with cover

- 30-5330-01
200x100x16mm

HOLLOWWARE



**Instruments Box
with Hooks**

- 30-5331-01 170x70x30mm
- 30-5331-02 180x80x40mm
- 30-5331-03 200x100x40mm
- 30-5331-04 230x120x50mm
- 30-5331-05 250x125x50mm
- 30-5331-06 300x150x50mm
- 30-5331-07 350x170x50mm
- 30-5331-08 400x200x90mm
- 30-5331-09 500x200x120mm



Instruments Box

- 30-5332-01 170x70x30mm
- 30-5332-02 180x80x40mm
- 30-5332-03 200x100x40mm
- 30-5332-04 230x120x50mm
- 30-5332-05 250x125x50mm
- 30-5332-06 300x150x50mm
- 30-5332-07 350x170x50mm
- 30-5332-08 400x200x90mm
- 30-5332-09 500x200x120mm



**Instruments Box
Perforated**

- 30-5333-01 200x100x40mm
- 30-5333-02 250x150x40mm
- 30-5333-03 300x150x40mm



Electric Sterilizer

- 30-5334-01 200x100x120mm
- 30-5334-02 250x120x140mm
- 30-5334-03 300x150x150mm
- 30-5334-04 350x170x170mm
- 30-5334-05 400x200x180mm
- 30-5334-06 450x230x190mm

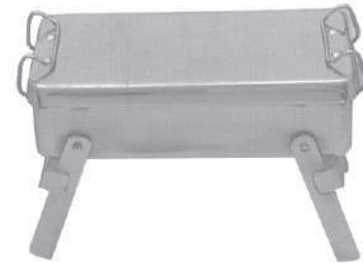

Non Electric Sterilizer

- 30-5335-01 200x100x65mm
- 30-5335-02 250x125x65mm
- 30-5335-03 300x150x100mm
- 30-5335-04 350x170x65mm
- 30-5335-05 400x200x100mm



Electric Sterilizer
30-5336-01
280x125x65mm

- 30-5337-01 125x80mm
- 30-5337-02 125x120mm
- 30-5337-03 150x100mm
- 30-5337-04 150x150mm
- 30-5337-05 180x180mm
- 30-5337-06 190x140mm
- 30-5337-07 190x190mm
- 30-5337-08 200x200mm
- 30-5337-09 240x120mm
- 30-5337-10 240x240mm
- 30-5337-11 290x140mm
- 30-5337-12 290x240mm
- 30-5337-13 290x290mm
- 30-5337-14 340x160mm
- 30-5337-15 340x340mm
- 30-5337-16 390x150mm
- 30-5337-17 390x200mm
- 30-5337-18 390x290mm



Sterilizer Drum

Instruments for Professionals



Bedpan Hand Made
 30-5338-01
 Standard



Bedpan Hand Made
 30-5339-01 Adult
 30-5339-02 Child



Bedpan Hand Made
 30-5340-01
 Standard



Bedpan Simple
 pressed body with handle
 30-5342-01 Adult
 30-5342-02 Child



Bedpan Sleeper Type
 30-5343-01 Adult
 30-5343-02 Child



Bedpan Chamber Port
 30-5344-01
 Standard

HOLLOWWARE

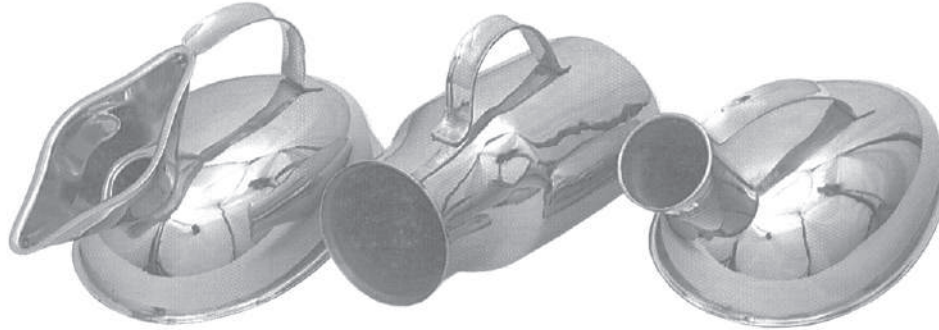

Urinal Female
 30-5345-01
 Standard

Urinal Male Vertical
 30-5346-01
 Standard

Urinal Male
 30-5347-01
 Standard



Bedpan perfection type seamless
 30-5348-01
 350x300mm



Bedpan perfection type
 30-5349-01 370x290mm
 30-5349-02 320x240mm



Dustbin
 30-5351-01 210mm
 30-5351-02 240mm
 30-5351-03 270mm
 30-5351-04 300mm



Pail/Bucket with Lid
 30-5350-01 06 Ltr
 30-5350-02 10 Ltr
 30-5350-03 15 Ltr



Measuring Jug
 30-5352-01 0.5 Ltr
 30-5352-02 1.0 Ltr
 30-5352-03 1.5 Ltr
 30-5352-04 2.0 Ltr



Douch Can/Irrigator
 30-5353-01 1.0 Ltr
 30-5353-02 1.5 Ltr
 30-5353-03 2.0 Ltr

Instruments for Professionals



Excellence in Quality Instruments

If you need full catalogue please contact us

Praise Corporation

Address : Muslim Town, Airport Road Kotli Behram Sialkot 51310
Pakistan.

Tel : +92-52-4273725

+92-52-4273723

+92-52-4264934

Cell / Whatsapp : +92 301 8606300

Fax : +92-52-4262310

Email : info@praise.com.pk

Muhammad Afzal Mughal (Director)

Email : afzal@praise.com.pk

